

HP 8116A 50 MHz Programmable Pulse/Function Generator

Operating, Programming and Servicing Manual

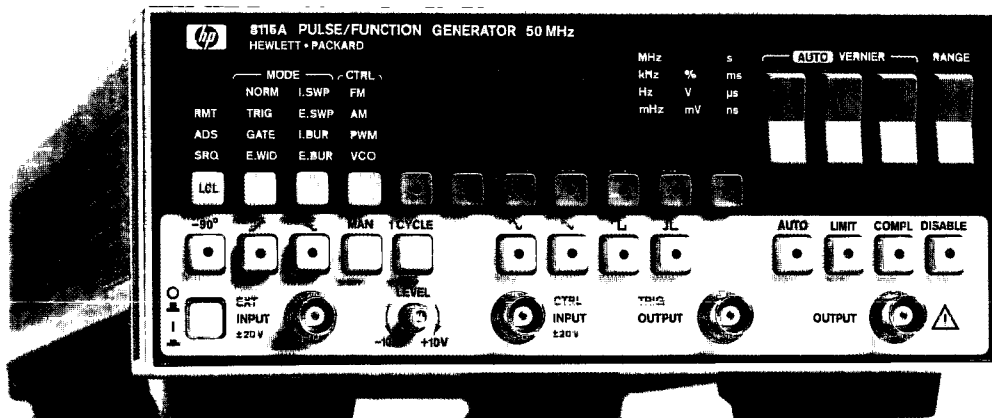

Printed in Federal Republic of Germany

Operating, Programming and Servicing Manual

HP 8116A 50 MHz Programmable Pulse/Function Generator

SERIAL NUMBERS

This manual applies directly to instruments with serial number 3001A08236 and 2901G09221.

If your instrument has a higher serial number, refer to Appendix C which contains manual changes for later instruments. Be sure to examine this supplement for changes which apply to your instrument, and record these changes in the manual.



HP Part No. 08116-90003

Microfiche Part No. 08116-95003

Printed in Federal Republic of Germany August 1990

First Edition
E0890

Notice

Subject Matter Notice

The information in this document is subject to change without notice.

Hewlett-Packard makes no warranty of any kind with regard to this printed material, including, but not limited to, the implied warranties of merchantability and fitness for a particular purpose.

Hewlett-Packard shall not be liable for errors contained herein or for incidental or consequential damages in connection with the furnishing, performance or use of this material.

Copyright

This document contains proprietary information which is protected by copyright. All rights are reserved. No part of this document may be photocopied, reproduced or translated into another language without the prior consent of Hewlett-Packard GmbH.

Introduction

General

This manual describes the following procedures for the HP 8116A 50 MHz Programmable Pulse/Function Generator:

- Installation
- Operation
- Programming
- Performance Testing
- Adjustment
- Servicing

A Microfiche version of this manual is available on 4×6 inch microfilm transparencies (refer to title page for order number). The microfiche package also includes the latest Manual Changes supplement and all relevant Service Notes.

Instruments Covered by This Manual



Figure 1-1. Serial Number Plate (US)

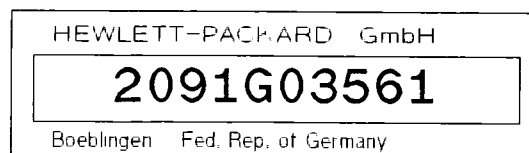

Figure 1-2. Serial Number Plate (FRG)

Attached to the rear of the instrument is a serial number plate (Figure 1-1 and Figure 1-2). The first four digits only change when there is a significant modification to the instrument, the last five digits are assigned to instruments sequentially. This manual applies directly to the instruments with the serial numbers quoted on the title page. For instruments with higher serial numbers, refer to the Manual Change sheets in Appendix C. To keep this manual up-to-date, Hewlett-Packard recommends that you periodically request the latest Manual Change supplement by quoting the part-number and print-date of this manual, both of which appear on the title page.

Instrument Description

The HP 8116A Programmable Pulse/Function Generator operates over the frequency range 1 mHz to 50MHz and is capable of driving a 16 V peak-to-peak amplitude output signal into a 50 Ω load. Capabilities include:

- Multi-waveform generation.
 - Sine
 - Square
 - Triangle
 - Pulse
- 7 ns transition time for pulse and squarewave.
- Variable pulse width down to 10 ns.
- AM/FM/PWM modulation modes.
- VCO control mode.
- HP-IB programmable.
- Internal and external logarithmic sweep (Option 001).
- Internal and external burst mode for all waveforms (Option 001).

The self-prompting operation and HP-IB programmability of the HP 8116A ensure that it is quick and easy to use in stand-alone and automatic-test applications.

Note



Throughout this manual, instrument keys are shown as key in the text. “Key” is the key name which appears above the key on the instrument front panel.

HP 8116A Options

- Option 001** Option 001 provides the HP 8116A with increased capabilities including:
- Logarithmic sweep (selectable internal or external triggering).
 - Counted burst (selectable internal or external triggering).
 - Hold input for sine, triangle and squarewave.

Note



Option 001 is not retrofittable, it is only available when ordering a new instrument.

Accessories

Included The HP 8116A is supplied complete with the following:

Item	HP Part Number
750 mA fuse for 220/240 V operation	2110-0813
or	
1.5 A fuse for 100/120 V operation	2110-0043
and	
Power cable	See Figure 3-2

Available The following accessories are available for the HP 8116A:

Item	HP Part Number
Carrying handle (Bail Handle Kit)	5062-4001
Rack mounting flange and filler panel for rack mounting a single HP 8116A	5062-3972
Rack mounting flange and Lock link kit for rack mounting two HP 8116As	5062-3974 5061-0094

Recommended Test Equipment

The recommended test equipment and accessories required to maintain the HP 8116A are listed in Table 1-1 and Table 1-2. Alternative equipment can be substituted provided that it meets or exceeds the critical specifications given in the tables.

Table 1-1. Recommended Test Equipment

Instrument	Recommended Model	Required Characteristics	Alternative	Use*
Counter	HP 5335A	50 MHz, Start/Stop, TI, A to B	HP5345A and HP 5363B	P, A
Digital Voltmeter	HP 3456A	DC .1 V-10 V, .004% acc.		P, A
Digital Multimeter	HP 3466A	AC .1 V-10 V, DC .1 mA-10 mA		P, A, T
Function Generator	HP 3325A	20 MHz, THD \leq .1%	HP3324A	P, A
Pulse Generator	HP 8112A	Pulse width 50 μ s - 500 ms		P
Digitizing Scope	HP 5412xT	1 GHz	HP 54503A	P, A
Attenuators	HP 33340C	20 dB, 2 W		P, A, T
Spectrum Analyzer	HP 8568B	100 Hz to 350 MHz		P, A
Signature Analyzer	HP 5005B			T

Table 1-2. Recommended Test Accessories

Accessory	Recommended Model	Required characteristics	Alternative	Use*
Attenuator	HP 33340C	20 dB		P, A
Logic Probe	HP 545A	TTL		T
Terminators	HP 11048C	1 W, 50 Ω , \pm 0.1 Ω		P, A
	HP10100C	2 W, 50 Ω		T

* P = Performance Test; A = Adjustments; T = Troubleshooting

Specifications

Introduction

All specifications in the following sections describe the instrument's warranted performance:

- Timing parameters
- Output parameters
- Waveform characteristics

All specifications apply with a 50 Ω load, after a 30 minute warm-up period, and are valid for ambient temperature in the range 15°C to 35°C. Refer to the General Characteristics section of this chapter for the performance derating factor to be used outside this temperature range (within the specified operating range of 0°C to 55°C) .

All operating characteristics given in the following sections describe typical performance figures which are non-warranted:

- Trigger modes
- Control modes
- Inputs and Outputs
- Additional features
- General characteristics

Timing Parameters

Unless otherwise stated, specifications are quoted for 50% amplitude in normal mode.

Frequency

Range

1.00 mHz to 50.0 MHz

Resolution

3 digits, best case 10 μ Hz (0.01 mHz)

Stability

$\pm 0.2\%$ (1 hour)

$\pm 0.5\%$ (24 hours)

Repeatability

Factor 4 better than accuracy

Accuracy

Frequency (FRQ)	Pulse mode or waveforms with 50% duty cycle	Waveforms with duty cycle \neq 50%
$1 \text{ mHz} \leq \text{FRQ} < 100 \text{ kHz}$	$\pm 3\% \pm 0.3 \text{ mHz}$	$\pm 3\% \pm 0.6 \text{ mHz}$
$100 \text{ kHz} \leq \text{FRQ} < 10 \text{ MHz}$	$\pm 5\%$	$\pm 10\%$
$10 \text{ MHz} \leq \text{FRQ} \leq 50 \text{ MHz}$	$\pm 5\%$	n/a
Jitter	$< 0.1\% + 100 \text{ ps}$	$< 0.2\% + 100 \text{ ps}$
RMS Jitter	$0.03\% + 25 \text{ ps}$	$0.06\% + 25 \text{ ps}$

Duty Cycle

Frequency (FRQ)	Range and Resolution	Accuracy
$1 \text{ mHz} \leq \text{FRQ} < 1 \text{ MHz}$	10% to 90% in steps of 1%	$\pm 0.5 \text{ LSD}^*$
$1 \text{ MHz} \leq \text{FRQ} < 10 \text{ MHz}$	20% to 80% in steps of 1%	$\pm 3.0 \text{ LSD}$
$10 \text{ MHz} \leq \text{FRQ} \leq 50 \text{ MHz}$	50% fixed	$\pm 5.0 \text{ LSD, typical}$

*Least Significant Digit (only units and tens are displayed)

Pulse Width

Range

10.0 ns to 999 ms
(Maximum = $1/\text{FRQ} - 10$ ns)

Resolution

3 digits, best case 100 ps (0.1 ns)

Accuracy

$\pm 5\% \pm 2$ ns

Repeatability

Factor 4 better than accuracy

Jitter

$0.2\% + 200$ ps (width ≤ 10 μs)
 0.1% (width > 10 μs)

Output Parameters

Note



Output voltages are specified for a 50 Ω load. Output voltages double when driving a high impedance load.

Output Impedance 50 Ω ± 2.5 Ω

Amplitude/Offset Amplitude and offset are independently variable within the following two level windows:

Level window:	±800 mV	±8.00 V
Amplitude range	10.0 mV to 99.9 mV (p-p)	100 mV to 16.0 V (p-p)
Amplitude resolution	3 digits (best case 0.1 mV)	3 digits (best case 1 mV)
Amplitude accuracy*	± 5%	± 5%
Offset range	0 to ±795 mV	0 to ±7.95 V
Offset resolution	3 digits (best case 0.1 mV)	3 digits (best case 1 mV)
Offset accuracy	±1% of programmed value ±1% of amplitude ±4 mV	±0.5% of programmed value ±1% of amplitude ±40 mV
Repeatability	Factor 4 better than accuracy	

* The amplitude accuracy for sine and triangle is specified at 1 kHz. The following table specifies the amplitude flatness at other frequencies for an output signal with 50% duty cycle:

Amplitude Flatness

Frequency (FRQ)	Sine	Triangle
1 mHz ≤ FRQ < 1 MHz	±3%	±3%
1 MHz ≤ FRQ < 10 MHz	±5%	±5%
10 MHz ≤ FRQ ≤ 50 MHz	+5%, -15%	+5%, -25%

Waveform Characteristics

Sine The following specifications apply for normal output mode and 50% duty cycle.

Total Harmonic Distortion (THD) < 1% (-40 dB), (10 Hz to 50 kHz).
This may increase by 3 dB below 10°C.

Harmonic signals < 2% (-34 dBc*)
for 50 kHz \leq FRQ < 1 MHz
< 7% (-23 dBc*)
for FRQ \geq 1 MHz
and amplitude < 8 V (p-p)

* dBc = dB relative to carrier (fundamental).

Triangle

Linearity < $\pm 3\%$ (10% to 90% of amplitude
and 100 mHz \leq FRQ < 1 MHz)

Square, Pulse

Transition time < 7 ns (10% to 90% of amplitude)

Pulse perturbations < $\pm 5\%$ of amplitude ± 2 mV

DC Output

A dc output voltage is generated when all waveform selection keys are deactivated.

Range 0 mV to ± 7.95 V

Resolution 3 digits, best case 1mV

Accuracy $\pm 0.5\% \pm 40$ mV

Repeatability Factor 4 better than accuracy

Operating Characteristics

The following sections give non-warranted information on the instrument's typical operating characteristics:

- Trigger modes
- Control modes
- Inputs and Outputs
- Additional features
- General characteristics

Trigger Modes

The external trigger signal referred to in this section is applied to the **EXT INPUT** BNC connector on the instrument front panel. The trigger level and sense are adjustable. An external trigger can be simulated by pressing the **(MAN)** key.

The period and duty cycle of the first output cycle may deviate up to 10% from subsequent cycles.

Note



* indicates that in this mode the startphase of sine and triangle waveforms is selectable between 0° and -90° using the **(-90°)** key.

Normal

A continuous output waveform is generated.

In Normal mode, all parameters can be automatically incremented or decremented with selectable resolution. Pressing the **(AUTO)** key enables this **AUTO** vernier, which can then be started by pressing the required vernier key. The **AUTO** vernier is stopped by an external trigger input or by pressing the **(AUTO)** key again.

*Trigger

Each active input edge triggers a single output cycle.

*Gate

The active level of the external signal enables output cycles. The first output cycle is synchronous with the active trigger slope. The last output cycle is always completed. The **(1 CYCLE)** key can be used to initiate a single output cycle.

External Width

In pulse waveform mode only, the external signal is shaped to determine output pulse width. This mode can be used for pulse recovery. The amplitude and offset controls are active.

**Logarithmic Sweep
(Option 001)**

For all waveforms the output signal frequency performs a logarithmic sweep between selected start and stop frequencies within the instrument's range (1 mHz to 50 MHz). The sweep time per decade is selectable between 10 ms and 500 s but restricted to intervals in the ratios 1:2:5. The sweep always starts with 0° output phase.

Internal sweep Continuous sweep cycles.

External sweep One sweep cycle is triggered by the external signal.

Marker frequency Programmable, see Marker Output.

Sweep ramp voltage See X-Output.

***Counted Burst
(Option 001)**

The HP 8116A generates a preprogrammed number (1 to 1999) of output cycles. The maximum burst frequency in this mode is 40 MHz.

Internal burst: Output bursts are repeatedly generated at programmable time intervals in the range 100 ns to 999 ms. This mode is not available in pulse waveform mode.

External burst: An output burst is triggered by the external signal. The minimum time between burst triggers is 100 ns.

The **1 CYCLE** key can be used to initiate a single output cycle.

Control Modes

An external control signal applied to the **CTRL INPUT** BNC connector can be used to modulate the output signal.

Frequency Modulation

Deviation $\pm 5\%$ maximum for ± 6 V input
Modulation bandwidth dc to 20 kHz (FRQ < 10 MHz)
dc to 3 kHz (FRQ \geq 10 MHz)

Amplitude Modulation

Modulation 100% with ± 2.5 V input
DSBSC (Double Side Band Suppressed Carrier) with +2.5 V, -7.5 V input
Modulation bandwidth dc to 1 MHz
Envelope distortion < 1% for modulation depth < 90%
(dc to 50 kHz and not complementary output)

Pulse Width Modulation

Modulation range Maximum of one decade with ± 6.5 V input
Pulse width ranges 10 ns to 1 s in eight adjacent decade ranges

Voltage Controlled Oscillator

The external voltage signal linearly sweeps the output frequency through two complete decades.

Modulation range Maximum of two decades with 0.1 V to 10 V input.
11 overlapping ranges from 1 mHz to 50 MHz with 2 decades per range.
Display shows the maximum frequency in the current range.
Modulation bandwidth dc to 1 kHz

Output modes

Complement	Selectable on/off
Disable	Disconnects output, default on switching on.
Limit	Implements present output levels as output limits.
Hold (Option 001)	External hold signal freezes output at current level. This mode only applies at frequencies < 10 Hz. In hold mode the output droop is < 0.01% of the amplitude per second.

Inputs and Outputs

External Input	Threshold level	± 10 V adjustable
	Trigger slope	Positive or negative or trigger off
	Minimum amplitude	500 mV (p-p)
	Input voltage limits	± 20 V
	Minimum pulse width	10 ns
	Input impedance	10 k Ω
Control Input	Input voltage limits	± 20 V
	Input impedance	10 k Ω
Hold Input (Option 001)	Hold level	> 2.5 V, or open circuit
	Run level	< 2.5 V
	Input voltage limits	± 20 V
	Input impedance	10 k Ω
Main Output	Range	± 8 V into 50 Ω
	Output Impedance	50 $\Omega \pm 2.5 \Omega$
	External voltage limits	Do not apply external voltage
	Short circuit capability	Maximum peak current 320 mA for up to 1 hour (15°C to 35°C)
Trigger Output	High level	2.4 V into 50 Ω
	Low level	0 V
	Active edge	Positive
	Output impedance	50 Ω
	Propagation Delay	60 ns (EXT INPUT to TRIG OUTPUT)
	External voltage limits	0 V, +5 V
	Duty cycle	Dependant on main output signal

**Marker Output
(Option 001)**

High level	2.4 V into 50 Ω
Low level	0 V
Edges	Positive at marker frequency Negative at start of sweep
Output impedance	50 Ω
External voltage limits	0 V, +5 V

**X-Output
(Option 001)**

Levels	0 V to 10 V, 1.5 V per sweep decade into high impedance.
Output impedance	1 k Ω
External voltage limits	0 V, +5 V

Additional Features

HP-IB Capability The HP 8116A is fully programmable except for the External Input trigger level.

Capability codes

SH1, AH1, T6, L4, SR1, RL1, PP0, DC1, DT1

Learn mode

All or individual parameters can be programmed

Learn string

Total 89 characters (161 characters with Option 001).

Message Interpretation times

Modes	30 ms
Timing parameters	50 ms
Voltages	250 ms

Execution times

5 ms (Offset 30 ms)

Transmission times

Status	15 ms
Learn string	1 ms per character

Self-test The instrument performs a self-test when switched on, and by HP-IB command.

Memory The current settings are stored when the instrument is switched off.

Error detection The instruments indicates incompatible settings on the front panel and via the status byte.

General Characteristics

Environmental	Storage temperature range	-40°C to 70°C
	Operating temperature range	0°C to 55°C
	*Specification temperature range	15°C to 35°C
	Humidity range	Up to 95% R.H., 0°C to 40°C

* The accuracy specification derating factor for temperatures outside this range is $1 + 0.05 \times d^{\circ}\text{C}$ where $d^{\circ}\text{C}$ is the temperature deviation below 15°C or above 35°C.

Power supply	■ 100/120/220/240 V rms (selectable) +5%, -10%
	■ 48-440Hz
	■ 120 VA maximum

Weight	Net	5.9 kg (13 lbs)
	Shipping	11.0 kg (24.4 lbs)

Dimensions	■ 89 mm high (3.5 in)
	■ 213 mm wide (8.4 in)
	■ 450 mm deep (17.7 in)

Recalibration period	1 year recommended
-----------------------------	--------------------

Installation

Introduction

This chapter provides installation instructions for the HP 8116A. It also includes information about initial inspection and damage claims, preparation for use, packaging, storage and shipment.

Safety Considerations

The HP 8116A is a Safety Class 1 instrument (instrument with an exposed metal chassis that is directly connected to earth via the power supply cable).

Before operation review the instrument and manual, including the red safety page, for safety markings and instructions. These must then be followed to ensure safe operation and to maintain the instrument in safe condition.

Initial Inspection

Inspect the shipping container for damage. If the container or cushioning material is damaged, keep it until the contents of the shipment have been checked for completeness and the instrument has been verified both mechanically and electrically.

The contents of the shipment should be as shown in Figure 1-2 plus any accessories that were ordered with the instrument. Procedures for checking the operation of the instrument are given in Chapter 6 Performance Tests.

If the contents are incomplete, mechanical damage or defect is apparent, or if the instrument does not pass the operators checks, notify the nearest Hewlett-Packard office. Keep the shipping materials for carrier's inspection. The HP office will arrange for repair or replacement without awaiting settlement.

Warning



To avoid hazardous electric shock, do not perform electrical tests when there are signs of shipping damage to any part of the outer covers or panels.

Power Requirements and Line Voltage Selection



Caution



BEFORE APPLYING AC LINE POWER TO THE HP 8116A, ensure that the instrument is set to the local line voltage and the correct line fuse is installed in the fuse holder.

The instrument requires a power source of 100, 120, 220 or 240 V rms (+5%, -10%) at a frequency of 48–440 Hz single phase. The maximum power consumption is 120 VA.

The line voltage selector switches can be seen through the lefthand side of the instrument cover towards the rear. The line voltage selector is set at the factory to the most commonly used line voltage for the country of destination. The instrument power fuse is located on the rear panel.

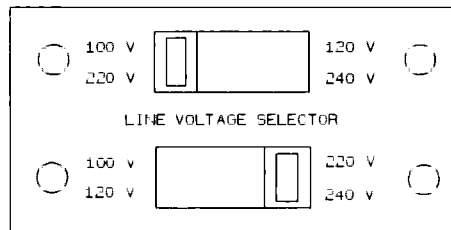

Figure 3-1. Line Voltage Selector Switches

Caution



Do not change the Line Voltage Selector switch settings with the instrument switched on or with power connected via the rear panel.

To change the selected line voltage:

1. Remove the power cord.
2. Remove the instrument top cover by releasing the captive securing screw at the rear and sliding the cover off.
3. Using a screwdriver, move the switches to the required position for the voltage to be used.
4. Replace the instrument top cover.
5. Fit the correct power fuse for the selected operating voltage.

Table 3-1. Line Voltage and Fuse Selection

Line Voltage	Fuse Type	HP Part Number
100 V / 120 V	1.5 A	2110-0043
220 V / 240 V	750 mA	2110-0813

Power Cable

Warning



To avoid the possibility of injury or death, the following precautions must be followed before the instrument is switched on:

- If the instrument is to be energised via an autotransformer for voltage reduction, ensure that the Common terminal is connected to the grounded pole of the power source
- The power cable must only be inserted into a socket outlet provided with a protective ground contact. The protective action must not be negated by the use of an extension cord without a protective conductor.
- Before switching on the instrument, the protective ground terminal of the instrument must be connected to the protective conductor of the power cable. This is verified by using the power cord which is supplied with the instrument.
- Intentional interruption of the protective ground connection is prohibited.

In accordance with international safety standards, the HP 8116A is equipped with a three-wire power cable. When connected to an appropriate ac power receptacle, this cable grounds the instrument cabinet. The type of cable shipped with each instrument depends on the country of destination. Refer to Figure 3-2 for the part numbers of the available cables.

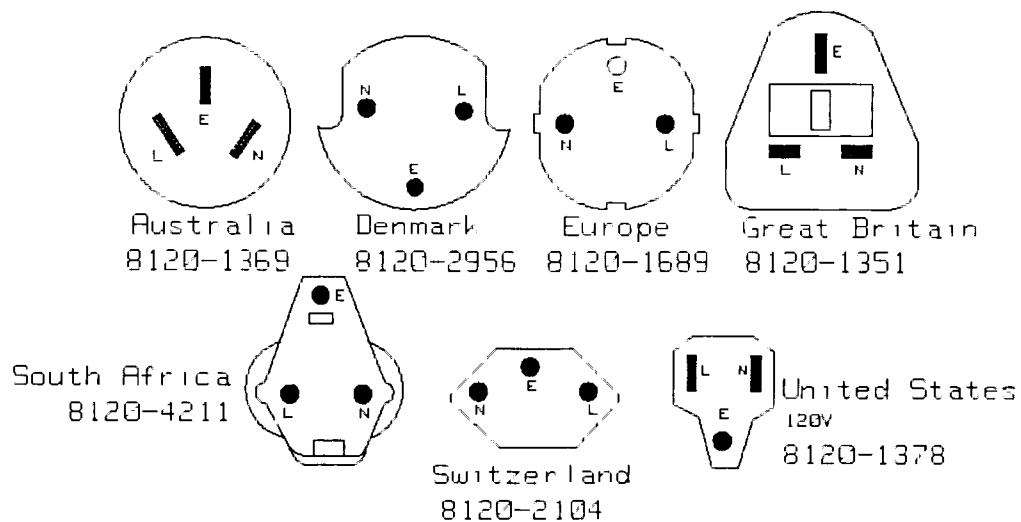

Figure 3-2. Power Cables & Plug Identification

The following work should be carried out by a qualified electrician - all local electrical codes being strictly observed. If the plug on the cable does not fit the power outlet, or the cable is to be attached to a terminal block, cut the cable at the plug end and re-wire it.

The color coding used in the cable will depend on the cable supplied. If a new plug is to be connected, it should meet local safety requirements and include the following features:

- Adequate load-carrying capacity (see specifications in Chapter 2).
- Ground connection.
- Cable clamp.

HP-IB Connector

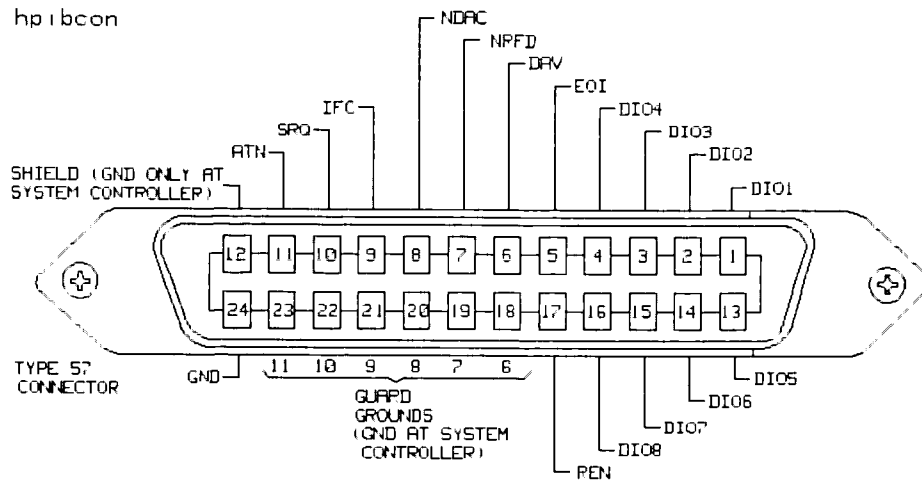

Figure 3-3. HB-IB Connector

The rear panel HP-IB connector (Figure 3-3), is compatible with the connector on Cable Assemblies 10833A, B, C and D. If a cable is to be locally manufactured, use male connector, HP part number 1251-0293.

HP-IB Logic Levels

The HP 8116A HP-IB lines use standard TTL logic, the levels being as follows:

- True = Low = digital ground or 0 Vdc to 0.4 Vdc,
- False = High = open or 2.5 Vdc to 5 Vdc.

All HP-IB lines have LOW assertion states. High states are held at 3.0 Vdc by pull-ups within the instrument. When a line functions as an input, approximately 3.2 mA of current is required to pull it low through a closure to digital ground. When a line functions as an output, it will sink up to 48 mA in the low state and approximately 0.6 mA in the high state.

Note



Isolation, the HP-IB line screens are not isolated from ground.

Operating Environment

Warning



The HP 8116A is not designed for outdoor use. To prevent potential fire or shock hazard, do not expose the HP 8116A to rain or other excessive moisture.

Temperature

The HP 8116A may be operated in temperatures from 0°C to 55°C.

Humidity

The HP 8116A may be operated in environments with humidity up to 95% (0°C to +40°C). However, the HP 8116A should be protected from temperatures or temperature changes which cause condensation within the instrument.

Instrument Cooling

The HP 8116A is equipped with a cooling fan mounted inside the rear panel. The instrument should be mounted so that air can freely circulate through it. When operating the HP 8116A, choose a location that provides at least 75 mm (3 inches) of clearance at the rear, and at least 25 mm (1 inch) of clearance at each side. Failure to provide adequate air clearance will result in excessive internal temperature, reducing instrument reliability.

Claims and Repackaging

If physical damage is evident or if the instrument does not meet specification when received, notify the carrier and the nearest Hewlett-Packard Service Office. The Sales/Service Office will arrange for repair or replacement of the unit without waiting for settlement of the claim against the carrier.

Storage and Shipment

The instrument can be stored or shipped at temperatures between -40°C and $+75^{\circ}\text{C}$. The instrument should be protected from temperature extremes which may cause condensation within it.

Return Shipment to HP

If the instrument is to be shipped to a Hewlett-Packard Sales/Service Office, attach a tag showing owner, return address, model number and full serial number and the type of service required.

The original shipping carton and packing material may be re-usable, but the Hewlett-Packard Sales/Service Office will also provide information and recommendations on materials to be used if the original packing is no longer available or reusable. General instructions for repacking are as follows:

1. Wrap instrument in heavy paper or plastic.
2. Use strong shipping container. A double wall carton made of 350-pound test material is adequate.
3. Use enough shock-absorbing material (3 to 4 inch layer) around all sides of the instrument to provide a firm cushion and prevent movement inside container. Protect control panel with cardboard.
4. Seal shipping container securely.
5. Mark shipping container **FRAGILE** to encourage careful handling.
6. In any correspondence, refer to instrument by model number and serial number.

HP 8116A 50 MHz Programmable Pulse/Function Generator

Operating and Programming Guide

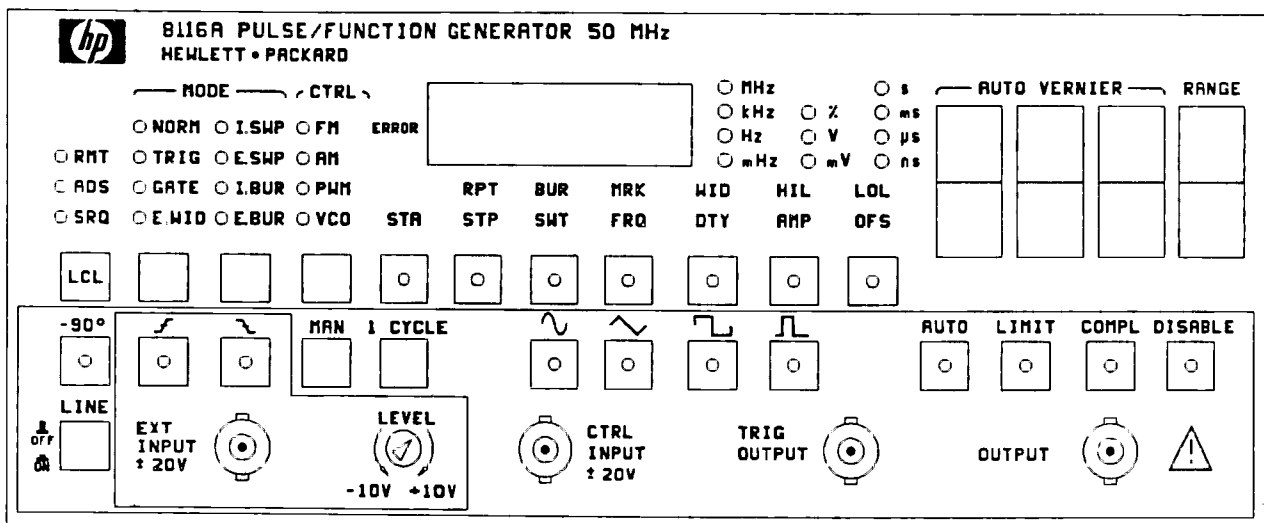

Printed in Federal Republic of Germany

Contents

4. Operating	
Introduction	4-1
Standard Parameter Set	4-3
Selecting Trigger Mode	4-4
Controlling the External Trigger	4-6
Selecting Control Mode	4-7
Selecting Output Waveform	4-11
Setting Parameters	4-12
Selecting Output Mode	4-15
Rear Panel	4-16
5. Operating Examples	
Introduction	5-1
Normal Mode	5-2
Trig Mode	5-3
Gate Mode	5-5
External Width Mode	5-6
Sweep Modes	5-7
Burst Modes	5-9
6. Programming	
General	6-1
IIP-IB Addressing	6-1
Local, Remote and Local Lockout	6-2
Introduction	6-3
Selecting Trigger Modes	6-4
Selecting Control Modes	6-5
Setting Parameters	6-6
Autovernier	6-8
Reading parameters	6-9
Selecting Output Modes	6-10
Reading the Current Settings	6-11
Timing	6-12
Error, Fault and Status Reporting	6-13
IIP-IB Status Byte	6-13
Timing Error (Bit 0)	6-14
Programming Error (Bit 1)	6-15
Syntax Error (Bit 2)	6-15
System Failure (Bit 3)	6-15
Autovernier in Progress (Bit 4)	6-16
Sweep in Progress (Bit 5)	6-16
Service Request (Bit 6)	6-16

Buffer not Empty (Bit 7)	6-16
HP-IB Universal Commands	6-17

7. Programming Examples

Introduction	7-1
Testing communication	7-2
Performing self-test	7-4
Using the Buffer Not Empty Flag	7-6
Using the Autovernier	7-8

Index

Figures

4-1. HP 8116A Front Panel	4-2
4-2. Trigger Mode Controls	4-4
4-3. External Trigger Controls	4-6
4-4. Control mode controls	4-7
4-5. Trigger & Control mode combinations	4-7
4-6. Amplitude Modulation	4-8
4-7. Pulse Width Modulation characteristics	4-9
4-8. VCO characteristics	4-10
4-9. Waveform controls	4-11
4-10. Parameter controls	4-12
4-11. Timing parameters	4-13
4-12. Level parameters	4-13
4-13. Output controls	4-15
4-14. Rear panel	4-16
4-15. HP-IB Address Switch (Factory setting)	4-16
5-1. Typical outputs in Normal mode	5-2
5-2. Typical signals in Trigger mode	5-3
5-3. Typical signals in Gate mode	5-5
5-4. Typical signals in External Width mode	5-6
5-5. Sweep Mode Signals	5-8
5-6. Typical outputs in Internal Burst mode	5-9
5-7. Typical signals in External Burst mode	5-9
6-1. HP-IB Address Switch (Factory setting)	6-1



Operating

Introduction

This chapter explains the use of all controls, indicators and connectors on the front and rear panels of the HP 8116A. Figure 4-1 and Figure 4-14 show the front and rear panel respectively. Each group of controls is explained in subsequent sections of this chapter under the following headings:

- Trigger Mode Selection
- External Trigger Controls
- Control Mode Selection
- Waveform Selection
- Parameter Selection
- Rear Panel

Examples are given in Chapter 5.

Before applying power to the IIP 8116A:

1. Read the red Safety Summary sheet at the front of this manual.
2. Ensure the Line Voltage Selector switches are set properly for the power source to be used. Refer to Chapter 3 on instrument installation if necessary

Caution



Do not change the Line Voltage Selector switches with the instrument switched on or with power connected to the rear panel.

3. Ensure that the device under test cannot be overdriven by the HP 8116A output (16 V p-p into 50 Ω ; 32 V p-p into high impedance).



Caution



Do not apply an external voltage or electrostatic discharge to the output connector.

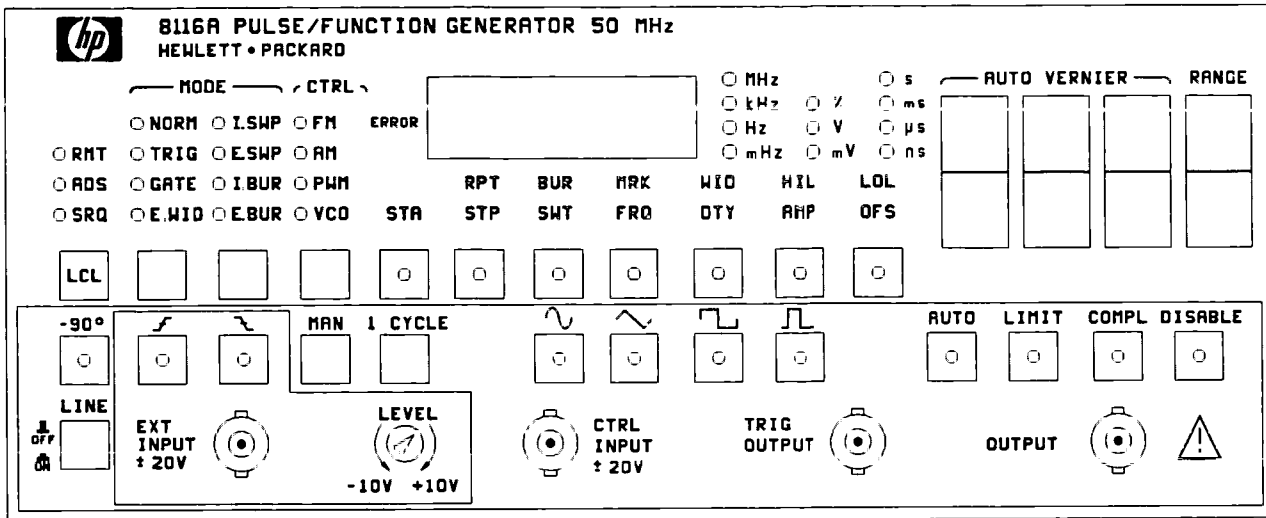

Figure 4-1. HP 8116A Front Panel

Switching On

The HP 8116A performs a "self test" when the power is switched on. All the front panel LEDs should light momentarily. If a fault is detected, an error code is displayed on the front panel digital display. The possible error codes are:

- A key is stuck in the depressed position.
- E11** There is a fault with the Auto Vernier/External Sweep trigger.
- E21** There is a fault in the internal repetition rate generator.
- E31** There is a fault in the internal width circuits. The width setting in pulse mode, and the time between bursts in internal burst mode are affected.
- E41/42** The output amplifier is faulty.
- E51-E62** Error indication for dedicated service tests.

Refer to Chapter 10.1 for more information on the error codes and their causes.

If the self-test is passed, the instrument automatically assumes the operating state which was active when last switched off, except that the output is disabled to protect the unit under test. If the

instrument battery has failed, the Standard Parameter Set is selected.

Standard Parameter Set

The Standard Parameter Set exists for two reasons. Firstly, if the instrument RAM becomes corrupted due to battery failure, the Standard Parameter Set will be selected when the instrument is switched on to give an error free display. Secondly, if an invalid combination of Operating and Control modes is selected, switching the instrument off and on again will revert to the Standard Parameter Set. The Standard Parameter Set is:

Trigger mode	Normal
Control mode	Off
Waveform	Sine
Frequency	1.00 kHz
Duty cycle	50%
High output level	0.5 V
Low output level	-0.5 V
Auto vernier	Off
Limit	Off
Complement	Off
Output Disable	On
Trigger	Off

If Option 001 is installed, Internal Sweep mode has the following standard parameters:

Start frequency	1.00 kHz
Stop frequency	100 kHz
Sweep time	50 ms
Marker frequency	1.00 kHz

If Option 001 is installed, Internal Burst mode has the following standard parameters.

Repeat time	100 ms
Burst length	1

Selecting Trigger Mode

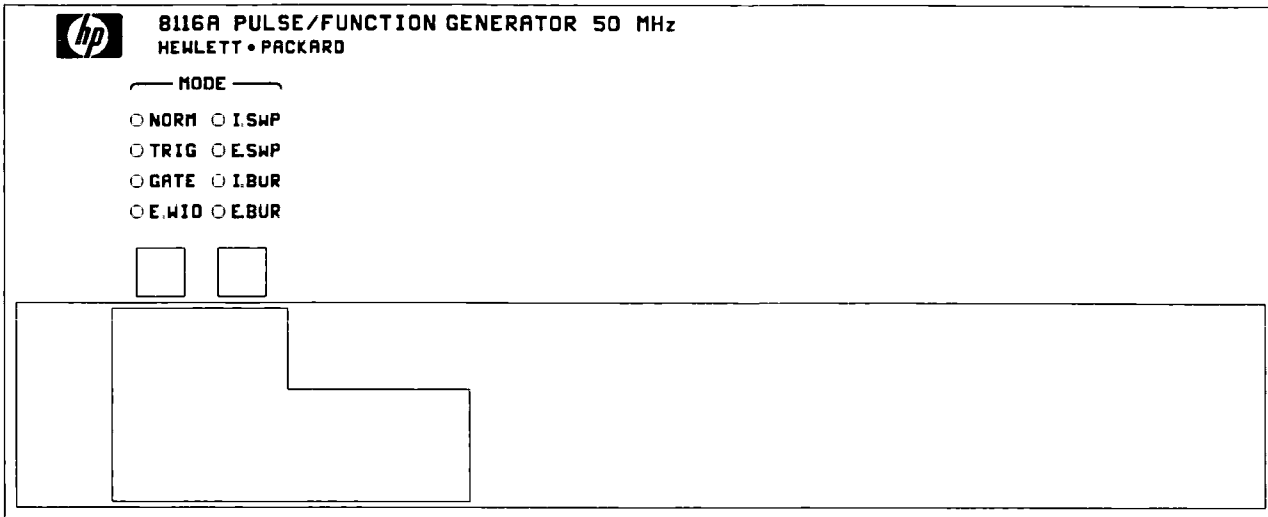

Figure 4-2. Trigger Mode Controls

Mode Selection

The currently active mode is shown by LED indicator. The trigger mode can be cycled through available options by pressing the key below the mode indicators.

The standard instrument offers the following trigger modes:

- | | |
|--------------|---|
| NORM | In normal mode a continuous output waveform is generated. |
| TRIG | In trigger mode each active input edge triggers a single output cycle. |
| GATE | In gate mode the active level of the external input signal enables output cycles. The first output cycle is synchronous with the active trigger slope. The last output cycle is always completed. |
| E.WID | In external width mode, which is only valid with pulse waveform, the external input signal is shaped to determine output pulse width. This mode can be used for pulse recovery. |

Optional Modes

The following additional trigger modes are available with Option 001.

- I.SWP** In internal sweep mode the instrument repeatedly sweeps the output frequency logarithmically between specified start and stop frequencies. The sweep time per frequency decade is selectable between 10 ms and 500 s in intervals in the ratio 1:2:5.
- E.SWP** In external sweep mode an external trigger initiates a single sweep cycle. A second trigger is required to reset the instrument to the start frequency.
- I.BUR** In internal burst mode the instrument repeatedly generates a specified number of output cycles (in the range 1 to 1999). The time between bursts can be selected in the range 100 ns to 999 ms.
- E.BUR** In external burst mode an external trigger initiates an output burst

Note



The maximum output frequency in a burst mode is 40 MHz

Controlling the External Trigger

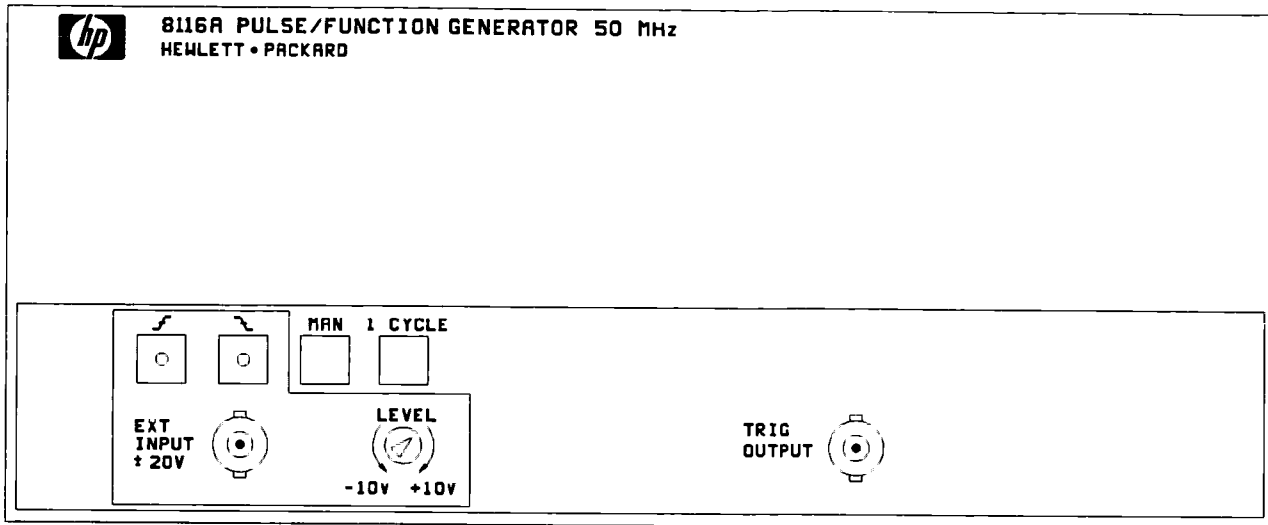

Figure 4-3. External Trigger Controls



The external trigger signal required in some trigger modes must be applied to the **EXT INPUT** BNC connector.

Caution



Do not apply voltages outside the range ± 20 V to the **EXT INPUT** connector.

Trigger Slope

Select a positive or negative trigger slope by pressing the  or  key respectively.

The current trigger slope is indicated by the LED on the key.

The trigger can be switched off by pressing the currently active key again. Both key LEDs will then be off.

Trigger Level

The trigger level can be varied in the range ± 10 V using the **LEVEL** adjuster.

Manual Trigger



This key can be used to simulate the external trigger signal.

Single Cycle

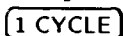

This key initiates a single output cycle in GATE, I.BUR and E.BUR modes.

Trigger Output

The trigger output provides a timing reference signal synchronised to the main output signal. Output levels are 0 and 2.4 V into 50 Ω .

Selecting Control Mode

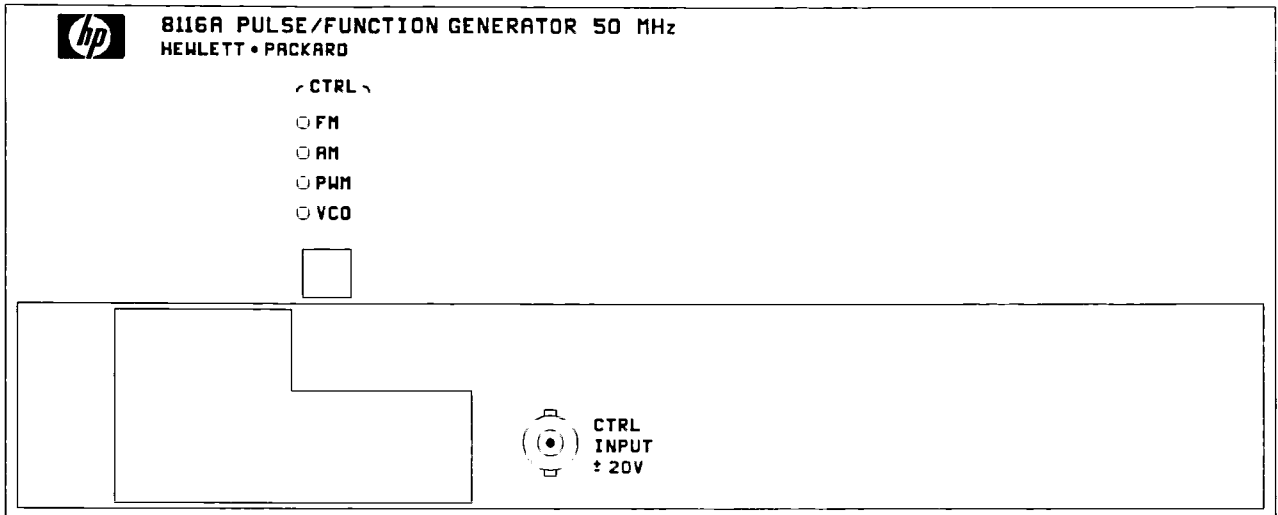

Figure 4-4. Control mode controls

Control Input

A signal can be applied to the control input to modulate or control the HP 8116A output signal.

Caution



Do not apply voltages outside the range ± 20 V to the CTRL INPUT connector.

Mode Selection

The currently active mode is shown by LED indicator. The trigger mode can be cycled through available options by pressing the key below the mode indicators. Figure 4-5 indicates the permitted combinations of control mode, trigger mode and output waveform:

		TRIGGER								
		NORM	TRIG	GATE	E. WID	I SWP	E. SWP	I BUR	E BUR	
CONTROL	MODE	FM	•	•	•	×	•	•	⌋	•
	AM	•	•	•	⌋	•	•	⌋	•	
	PWM	⌋	⌋	⌋	×	⌋	⌋	×	⌋	
	VCO	•	•	•	×	×	×	•	•	

• = All waveforms × = Invalid combination
 ⌋ = Pulse waveform only ⌋ = All waveforms except pulse

Figure 4-5. Trigger & Control mode combinations

Frequency Modulation FM

The output signal frequency can be modulated to a maximum of $\pm 5\%$ of the programmed value by applying a control voltage in the range ± 6 V.

Amplitude Modulation AM

The output signal amplitude can be modulated from 0 to 100% using a ground symmetrical control voltage in the range ± 2.5 V. Double Side Band Supressed Carrier DSBSC) is obtained using a control voltage in the range $+2.5$ V to -7.5 V which gives 200% modulation.

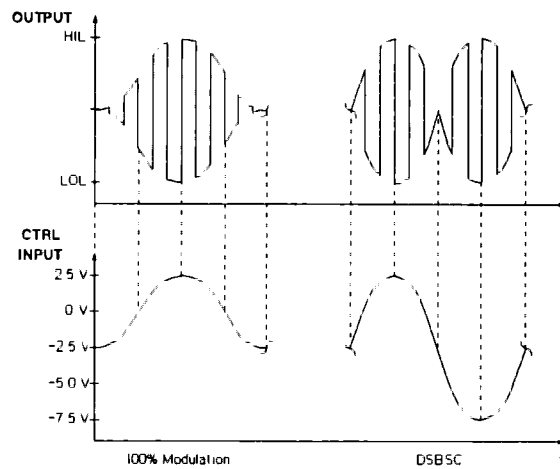

Figure 4-6. Amplitude Modulation

Pulse Width Modulation PWM

In pulse mode, the pulse width can be controlled using a control voltage in the range ± 6.5 V. There are 8 non-overlapping pulse width ranges available, as shown below:

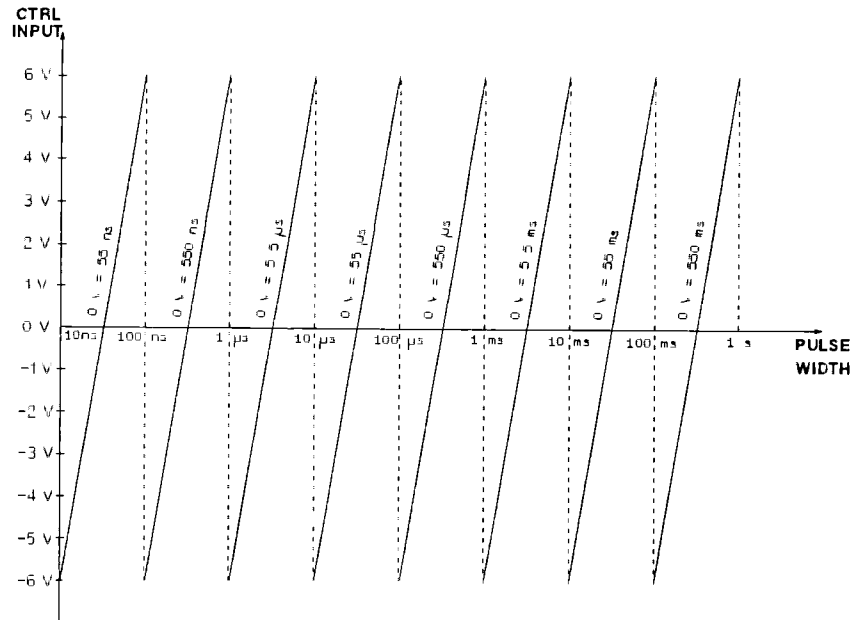

Figure 4-7. Pulse Width Modulation characteristics

The pulse width range can be chosen by selecting the WID parameter. The pulse width for a CTRL INPUT voltage of 0 V is displayed. Use the **RANGE** key to move between ranges.

Note



The available pulse width ranges are limited by the current output frequency.

Voltage Controlled Oscillator VCO

The output signal frequency can be controlled linearly over 2 decades by applying a control voltage in the range 0.1 V to 10 V. Eleven overlapping frequency ranges are available.

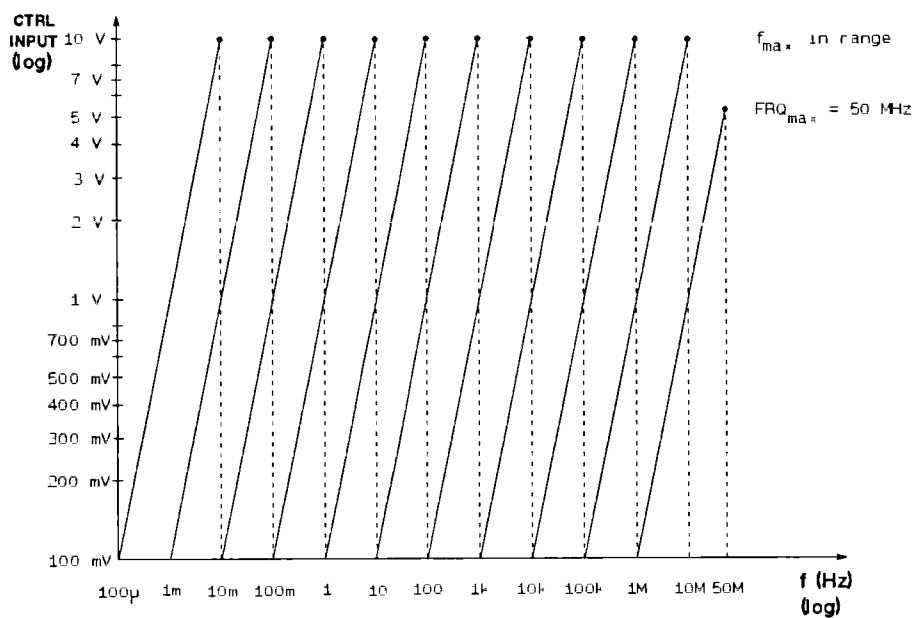

Figure 4-8. VCO characteristics

The output frequency range can be chosen by selecting the FRQ parameter. The maximum frequency in the current VCO range is displayed. Use the **RANGE** key to move between ranges.

Selecting Output Waveform

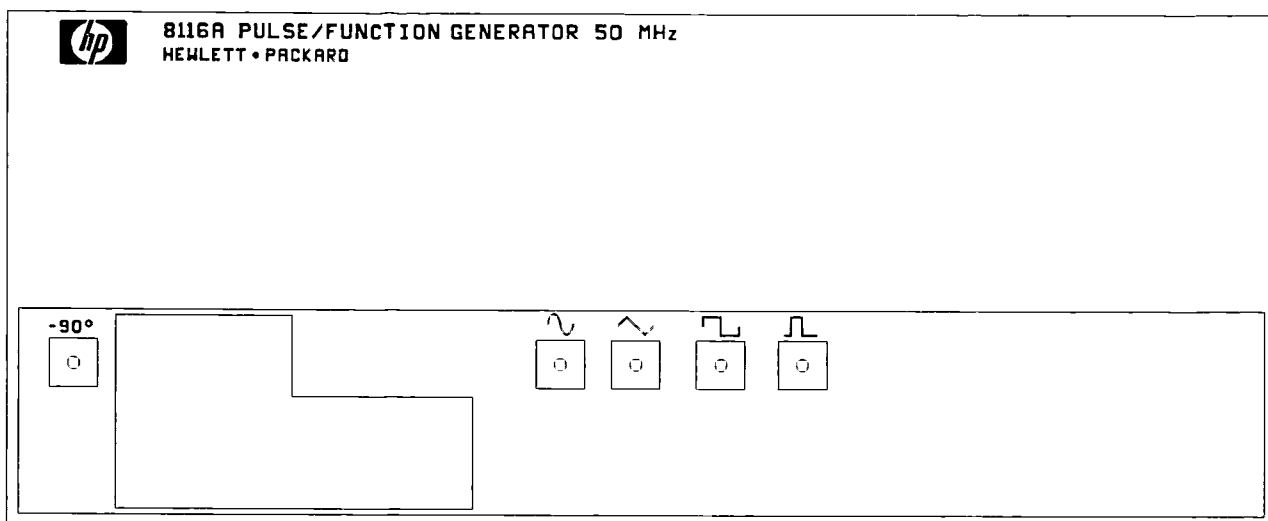

Figure 4-9. Waveform controls

Waveform Select the desired waveform by pressing the appropriate key. The key LED illuminates to indicate the current waveform.

To select DC output, make sure that the output amplitude (AMP) is ≥ 100 mV and then press the currently active (LED illuminated) waveform key again. All waveform-key LEDs will now be off, indicating DC output has been selected.

Start Phase This key selects an output start phase of -90° in TRIG, GATE, I.BUR and E.BUR modes. This allows haversine and havertriangle outputs to be generated.

-90°

Setting Parameters

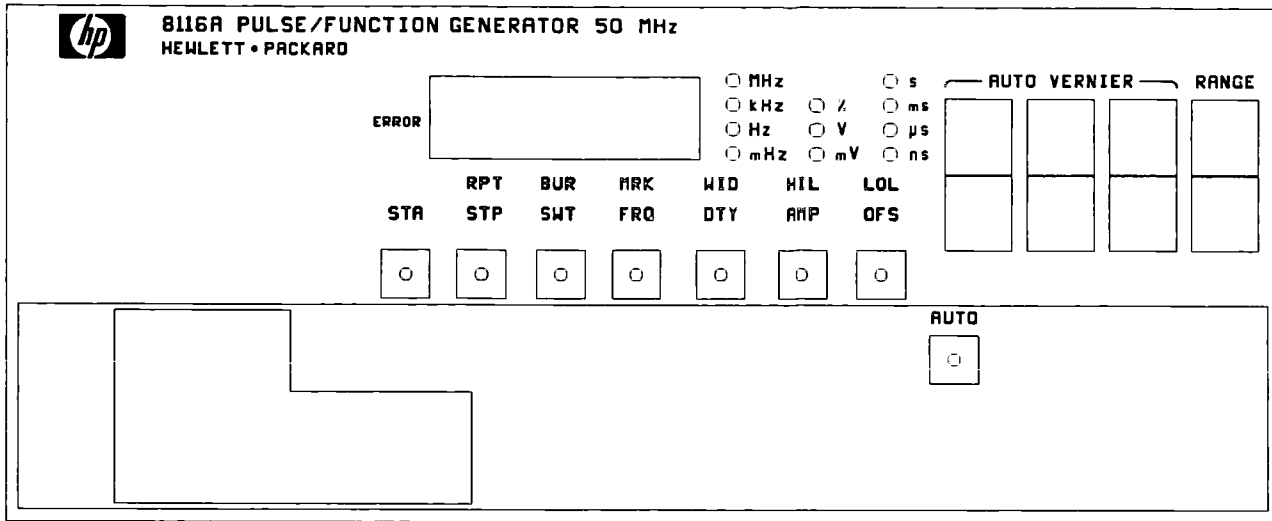

Figure 4-10. Parameter controls

The parameters available for selection depend on the currently selected modes and waveform. All parameters are listed below; timing and level parameters are illustrated in Figure 4-11 and Figure 4-12

Standard	Opt. 001	Description
AMP		Output amplitude
BUR		Output burst length in cycles
DTY		Duty cycle
FRQ		Output frequency
HIL		High level of output
LOL		Low level of output
	MRK	Marker frequency
OFS		Output signal offset
	RPT	Repeat interval
	STA	Start frequency
	STP	Stop frequency
	SWT	Sweep time
WID		Pulse width

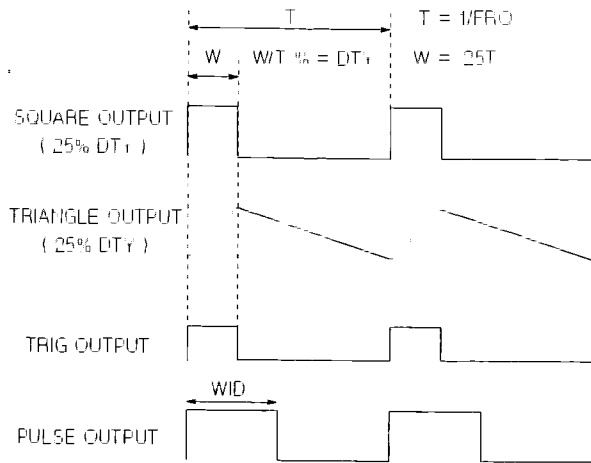

Figure 4-11. Timing parameters

Selection

Pressing a parameter key selects the parameter indicated by the illuminated mnemonic above the key.

Note



Output level can be set in terms of amplitude (AMP) and offset (OFS), or in terms of high and low level (HIL,LOL). Refer to Figure 4-12. Pressing the appropriate parameter key a second time will select the alternative parameter associated with that key.

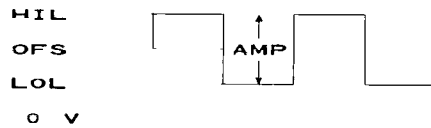

Figure 4-12. Level parameters

The current value of the selected parameter is shown on the digital display. The parameter units are indicated by the LEDs to the right of the display.

Adjustment

The currently selected parameter is adjusted using the **VERNIER** and **RANGE** rocker keys. Each **VERNIER** key increments or decrements the corresponding digit in the digital display. Similarly, the **RANGE** key increases or decreases the parameter value by a factor of 10.

Autovernier

AUTO

In normal trigger mode only, a chosen parameter can be automatically incremented or decremented with selectable resolution. Pressing the **AUTO** key enables the Autovernier, which can then be started by pressing a **VERNIER** key. The **VERNIER** key determines the direction and step size used.

The Autovernier continues until one of the following conditions arises:

- A timing error occurs
- An instrument specification limit is reached
- An output level limit is reached

Autovernier mode can be switched off by:

- An external trigger input.
- Pressing the **AUTO** key again.
- Pressing any key other than the **VERNIER** keys.

Selecting Output Mode

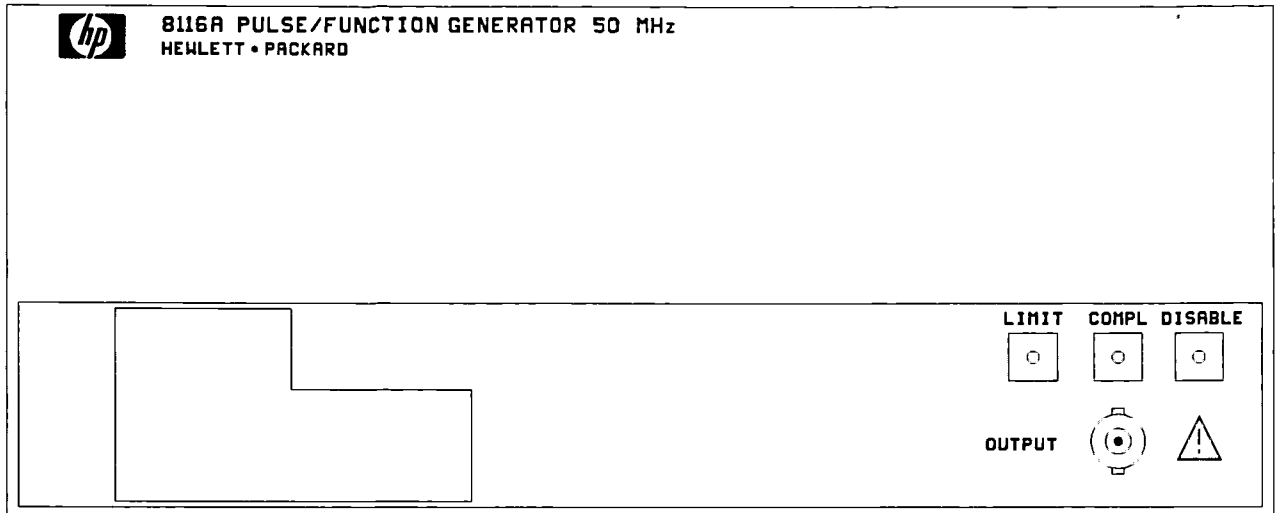

Figure 4-13. Output controls

Limited Output

LIMIT

Pressing the **LIMIT** key sets the current high and low output levels (HIL,LOL) as output limits which cannot be exceeded until limited output mode is switched off. While limited output mode is active, the high and low output levels (HIL,LOL) can be varied within the output limits.

Limited output mode is switched off by pressing the **LIMIT** key again. The **LIMIT** key LED is lit when this mode is active.

Complement Output

COMPL

Pressing the **COMPL** key complements the instrument output, pressing the key again returns the instrument output to normal.

The **COMPL** key LED is lit when the output is complemented.

Disabled Output

DISABLE

Pressing the **DISABLE** key disables the instrument output, pressing the key again enables the output.

The **DISABLE** key LED is lit when the output is disabled.

Rear Panel

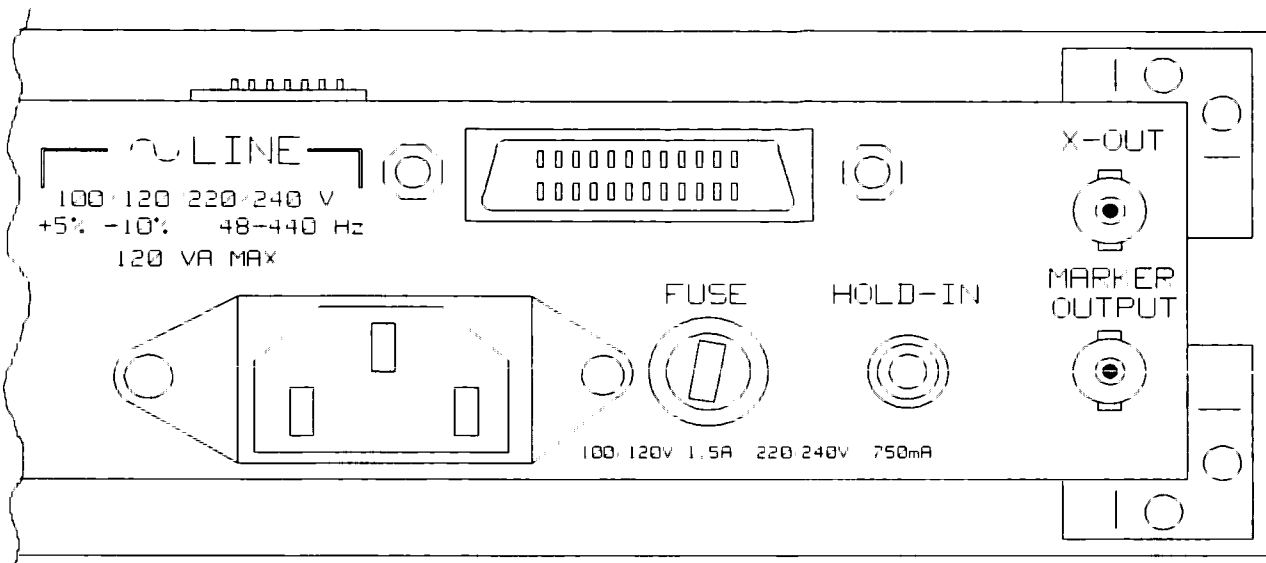

Figure 4-14. Rear panel

HP-IB Address

When the instrument is switched on it determines its HP-IB address from the address switches on the rear panel. The address switches are preset at the factory to 16 decimal:



Figure 4-15. HP-IB Address Switch (Factory setting)

To change the address, change the bit settings on the rear panel switch, then press the **LCL** key or switch the instrument off and on again.

Pressing the **LCL** key will display the current HP-IB address in decimal on the front panel digital display.

HP-IB Connector

Refer to Figure 3-3 for a definition of the HP-IB connector pins.

**Hold Input
(Option 001)**

The hold input is a TTL compatible input which freezes the output signal when a high level (> 2.5 V) signal is received.

The hold input function only operates for sine, triangle and squarewaves at frequencies < 10 Hz.

**X-Output
(Option 001)**

The X-Output provides an increasing output voltage with logarithmically increasing frequency in sweep modes.

0 V always corresponds to the sweep start frequency. The voltage increases at 1.5 V per frequency decade to a maximum of 10 V.

**Marker Output
(Option 001)**

The marker output generates a TTL level positive edge (0 to 2.4 V into 50 Ω) when the instrument frequency reaches the preprogrammed marker frequency during a sweep.

Fuse

The fuseholder accepts standard fuses to provide instrument protection in case of current overload. Refer to Table 3-1 for appropriate fuse selection.

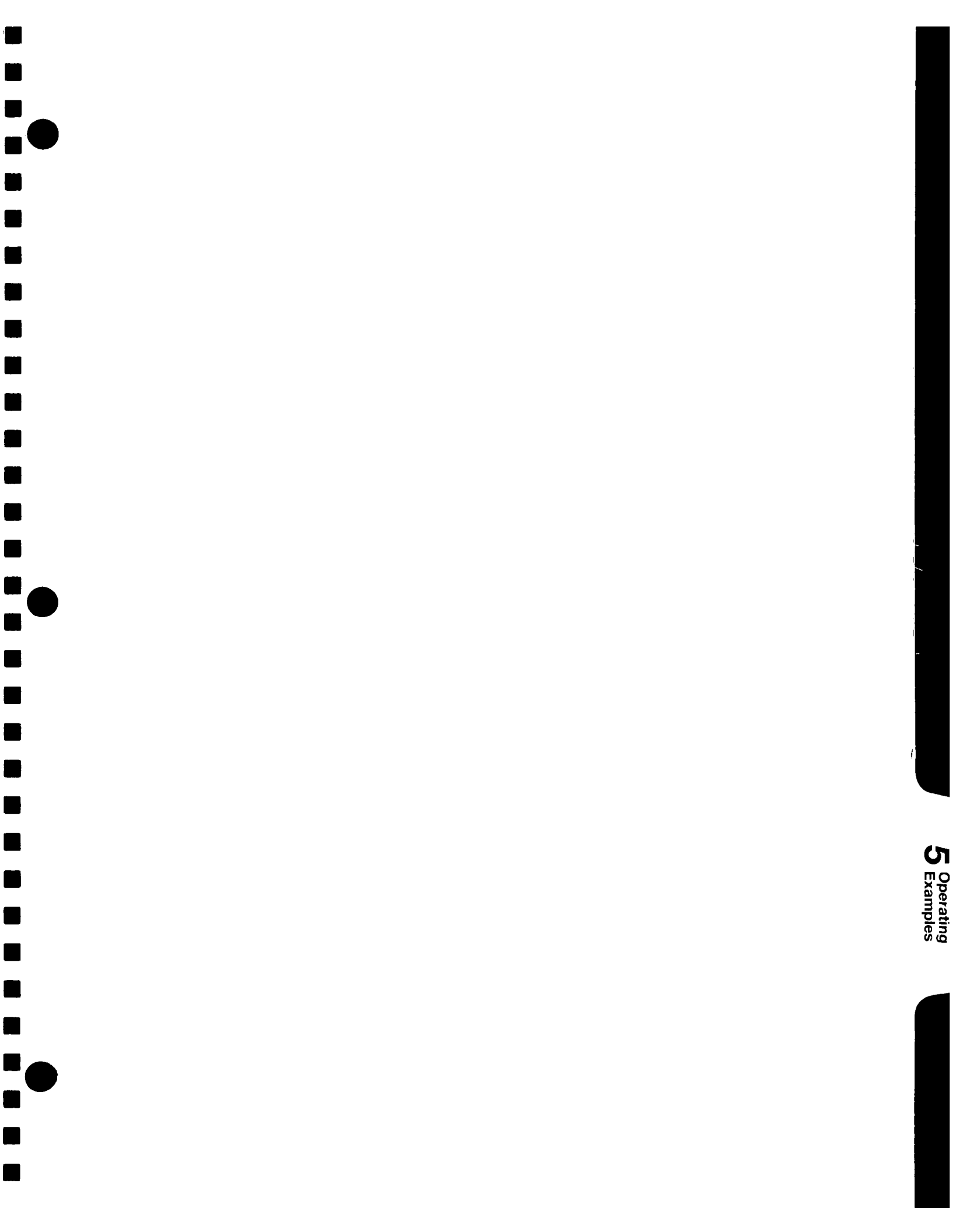

Operating Examples

Introduction

The following examples show how the instrument can be set up for each type of trigger mode. The examples list the basic operating steps in the order in which they would normally occur after switching on.

Normal Mode

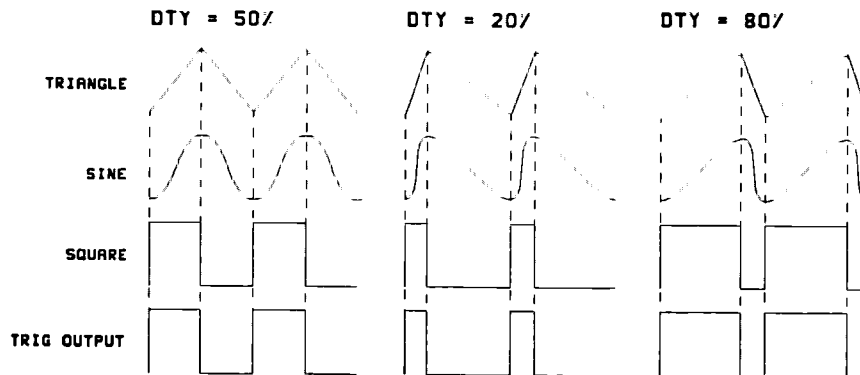

Figure 5-1. Typical outputs in Normal mode

1. Switch the instrument on using the line switch.
2. If necessary, select normal mode by repeatedly pressing the standard mode key until the NORM LED is lit.
3. Select the desired output waveform by pressing the key with the appropriate symbol.
4. Select each output parameter in turn by pressing its associated key. Adjust the parameter value using the **VERNIER** and **RANGE** keys. Refer to "Setting Parameters" in Chapter 4 for additional information on parameter adjustment.

Note



For level parameters HIL, LOL, AMP, OFS, pressing the parameter key a second time will select the alternative parameter associated with that key.

5. If a modulated output is required, select the required modulation using the **CTRL** key. Apply the modulating signal to the CTRL INPUT connector. Refer to "Selecting Control Mode" in Chapter 4 for more information on modulating the output signal.

Note



You may wish to set up Output Limits as described in "Selecting Output Mode" in Chapter 4 to protect the device under test.

6. Press the **DISABLE** key to turn off output disable mode and enable the output.

Trig Mode

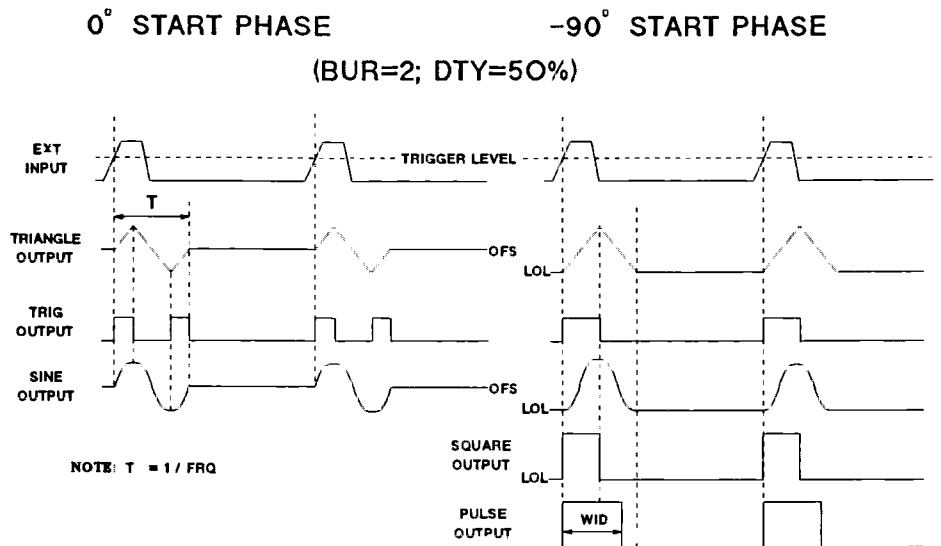

Figure 5-2. Typical signals in Trigger mode

1. Switch the instrument on using the line switch.
2. If necessary, select Trig mode by repeatedly pressing the standard mode key until the TRIG LED is lit.
3. Select the desired output waveform by pressing the key with the appropriate symbol
4. Select each output parameter in turn by pressing its associated key. Adjust the parameter value using the **VERNIER** and **RANGE** keys. The selected frequency **FRQ** must be higher than the external trigger frequency. Refer to "Setting Parameters" in Chapter 4 for additional information on parameter adjustment.

Note



For level parameters HIL, LOL, AMP, OFS, pressing the parameter key a second time will select the alternative parameter associated with that key.

5. Apply the external trigger signal to the EXT INPUT and select trigger slope and level as required. Refer to "Controlling the External Trigger" in Chapter 4 for information on the trigger controls. Triggering can also be simulated using the **MAN** key.
6. If a modulated output is required, select the required modulation using the **CTRL** key. Apply the modulating signal to the CTRL INPUT connector. Refer to "Selecting Control Mode" in Chapter 4 for more information on modulating the output signal.

Note



You may wish to set up Output Limits as described in "Selecting Output Mode" in Chapter 4 to protect the device under test.

7. Press the **DISABLE** key to turn off output disable mode and enable the output.

Gate Mode

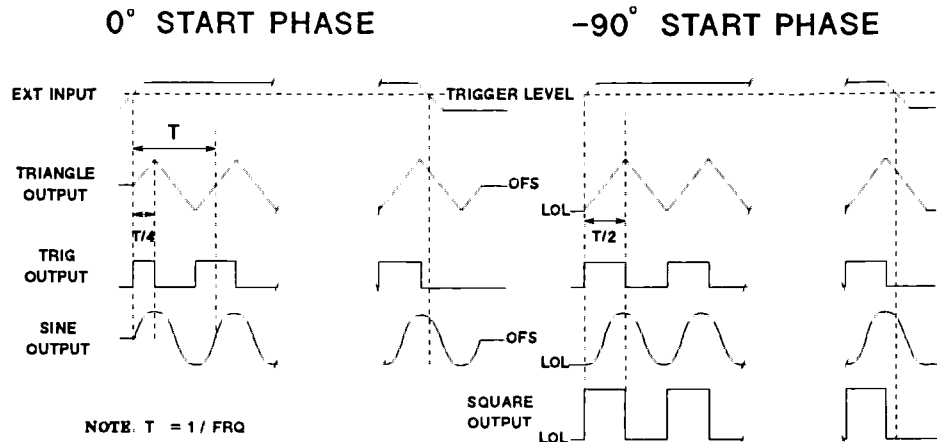

Figure 5-3. Typical signals in Gate mode

1. Switch the instrument on using the line switch.
2. If necessary, select gate mode by repeatedly pressing the standard mode key until the gate LED is lit.
3. Select the desired output waveform by pressing the key with the appropriate symbol.
4. Select each output parameter in turn by pressing its associated key. Adjust the parameter value using the **VERNIER** and **RANGE** keys. Refer to "Setting Parameters" in Chapter 4 for additional information on parameter adjustment.

Note



For level parameters HIL, LOL, AMP, OFS, pressing the parameter key a second time will select the alternative parameter associated with that key.

5. Apply the external gating signal to the EXT INPUT and select trigger slope and level as required. Refer to "Controlling the External Trigger" in Chapter 4 for information on the trigger controls. Triggering can also be simulated using the **MAN** key.
6. If a modulated output is required, select the required modulation using the **CTRL** key. Apply the modulating signal to the CTRL INPUT connector. Refer to "Selecting Control Mode" in Chapter 4 for more information on modulating the output signal.

Note



You may wish to set up Output Limits as described in "Selecting Output Mode" in Chapter 4 to protect the device under test.

7. Press the **DISABLE** key to turn off output disable mode and enable the output.

External Width Mode

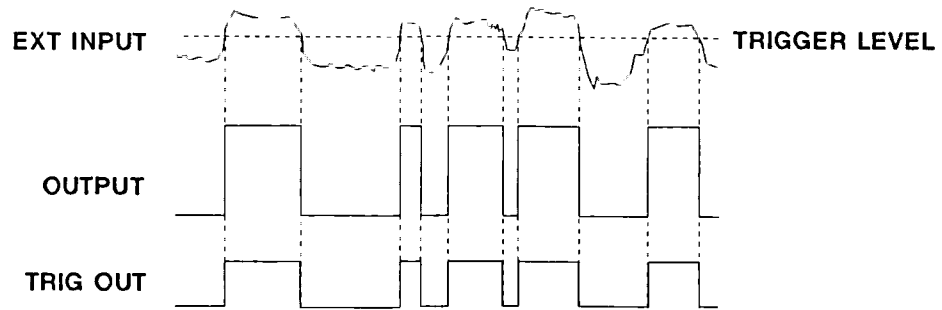

Figure 5-4. Typical signals in External Width mode

1. Switch the instrument on using the line switch.
2. If necessary, select external width mode by repeatedly pressing the standard mode key until the E.WID LED is lit.
3. Select pulse waveform by pressing the key with the appropriate symbol.
4. Select each output parameter in turn by pressing its associated key. Adjust the parameter value using the **VERNIER** and **RANGE** keys. Refer to “Setting Parameters” in Chapter 4 for additional information on parameter adjustment.

Note



For level parameters HIL, LOL, AMP, OFS, pressing the parameter key a second time will select the alternative parameter associated with that key.

5. Apply the external signal to be shaped to the EXT INPUT and select trigger slope and level as required. Refer to “Controlling the External Trigger” in Chapter 4 for information on the trigger controls.
6. If an amplitude modulated output is required select AM control mode using the **CTRL** key and apply the modulating signal to the CTRL INPUT connector.

Note



You may wish to set up Output Limits as described in “Selecting Output Mode” in Chapter 4 to protect the device under test.

7. Press the **DISABLE** key to turn off output disable mode and enable the output.

Sweep Modes

1. Switch the instrument on using the line switch.
2. If necessary, select the required sweep mode by repeatedly pressing the optional mode key until the I. or E. SWP LED is lit.
3. Select the desired output waveform by pressing the key with the appropriate symbol
4. Select each output parameter in turn by pressing its associated key. Adjust the parameter value using the **VERNIER** and **RANGE** keys. Refer to “Setting Parameters” in Chapter 4 for additional information on parameter adjustment. The sweep related parameters STA, STP, SWT, MRK are illustrated in the following timing diagrams.

Note



For level parameters HIL, LOL, AMP, OFS, pressing the parameter key a second time will select the alternative parameter associated with that key.

5. In External Sweep mode apply the external trigger signal to the EXT INPUT and select trigger slope and level as required. Refer to “Controlling the External Trigger” in Chapter 4 for information on the trigger controls. Triggering can also be simulated using the **MAN** key. In either case remember that two triggers are required to complete one sweep, as shown in the following timing diagrams.
6. If a modulated output is required, select the required modulation using the **CTRL** key. Apply the modulating signal to the CTRL INPUT connector. Refer to “Selecting Control Mode” in Chapter 4 for more information on modulating the output signal.

Note



You may wish to set up Output Limits as described in “Selecting Output Mode” in Chapter 4 to protect the device under test.

7. Press the **DISABLE** key to turn off output disable mode and enable the output.

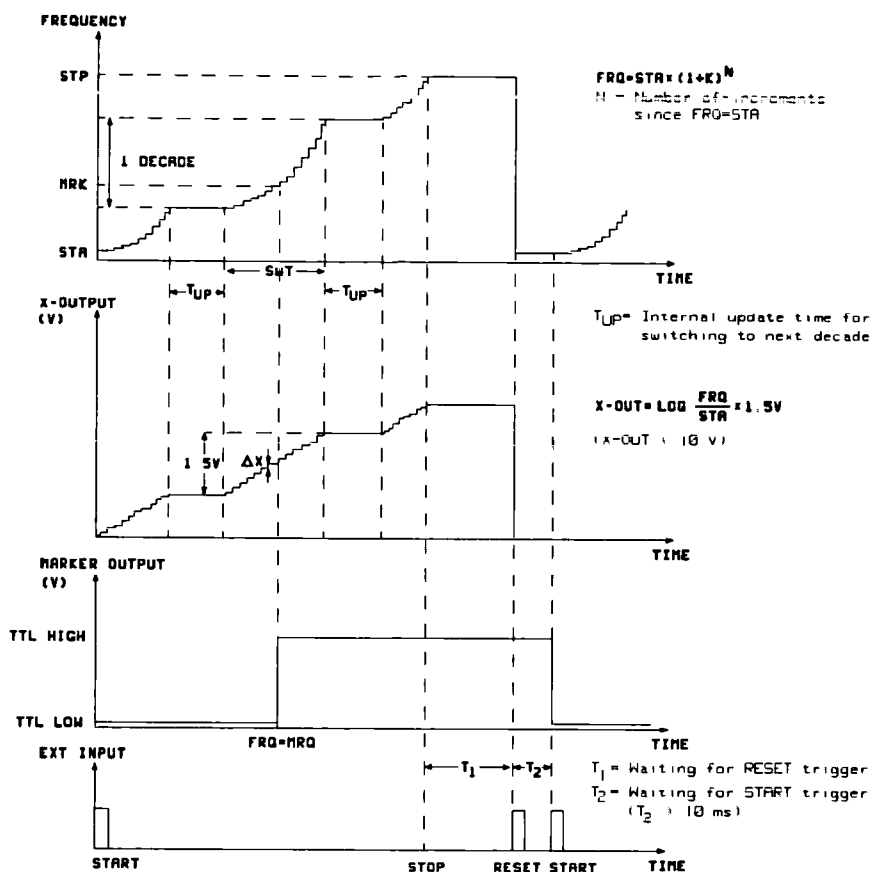

Figure 5-5. Sweep Mode Signals

Table 5-1.

SWT	K	N	ΔX
10 ms	0.0625	38	40 mV
20 ms	0.03125	75	20 mV
50 ms	0.015625	149	10 mV
100 ms	0.015625	149	10 mV
200 ms	0.015625	149	10 mV
500 ms	0.015625	149	10 mV
1 s	0.015625	149	10 mV
2 s	0.015625	149	10 mV
5 s	0.015625	149	10 mV
10 s	0.015625	149	10 mV
20 s	0.015625	149	10 mV
500 s	0.015625	149	10 mV
100 s	0.015625	149	10 mV
200 s	0.015625	149	10 mV
500 s	0.015625	149	10 mV

Burst Modes

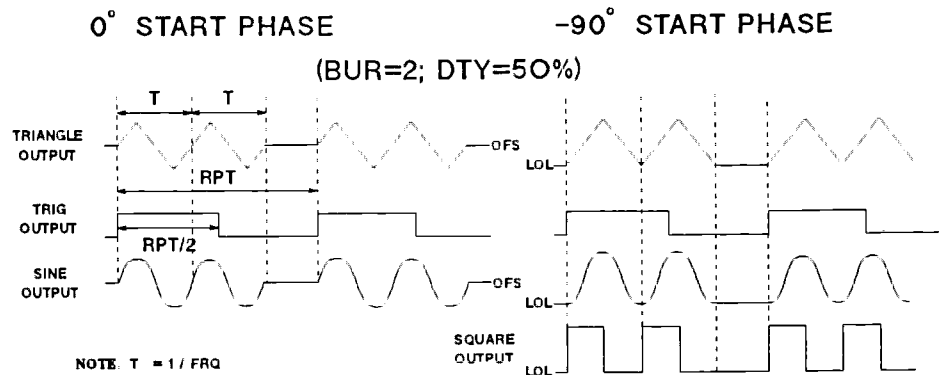

Figure 5-6. Typical outputs in Internal Burst mode

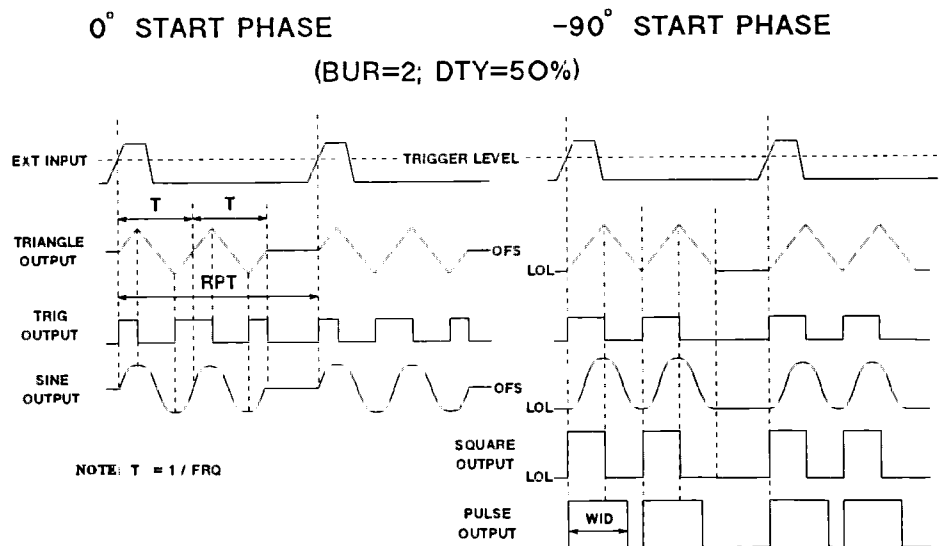

Figure 5-7. Typical signals in External Burst mode

1. Switch the instrument on using the line switch.
2. If necessary, select the required burst mode by repeatedly pressing the optional mode key until the I. or E. BUR LED is lit.
3. Select the desired output waveform by pressing the key with the appropriate symbol.
4. Select each output parameter in turn by pressing its associated key. Adjust the parameter value using the **VERNIER** and **RANGE**

keys. Refer to “Setting Parameters” in Chapter 4 for additional information on parameter adjustment. The burst related parameters BUR, RPT, are illustrated in the timing diagrams which follow.

Note



For level parameters HIL, LOL, AMP, OFS, pressing the parameter key a second time will select the alternative parameter associated with that key.

5. In external burst mode apply the external trigger signal to the EXT INPUT and select trigger slope and level as required. Refer to “Controlling the External Trigger” in Chapter 4 for information on the trigger controls. Triggering can also be simulated using the **MAN** key.
6. If a modulated output is required, select the required modulation using the **CTRL** key. Apply the modulating signal to the CTRL INPUT connector. Refer to “Selecting Control Mode” in Chapter 4 for more information on modulating the output signal.

Note



You may wish to set up Output Limits as described in “Selecting Output Mode” in Chapter 4 to protect the device under test.

7. Press the **DISABLE** key to turn off output disable mode and enable the output.



Programming

General

In remote mode, all HP 8116A settings, except EXT INPUT trigger level, are programmable via the HP-IB. The HP 8116A also provides error messages and reports operating parameters when requested by the controller.

In addition, the instrument responds to a sub-set of the universal HP-IB commands.

This chapter describes the valid programming mnemonics and syntax for the HP 8116A. Example program statements are based on HP BASIC 5.0/5.1 for the HP 9000 Series 200/300 controllers. Example program statements also assume that the instrument's HP-IB address is 16 decimal.

This manual does not discuss the HP-IB protocol or hardware. For detailed information on the HP-IB refer to any of the following publications:

- IEEE Interface Standard 488-1975
- ANSI Interface Standard MC1.1.
- HP Publication 59401-90030
- HP Publication 5952-0058
- HP Publication 5952-0156

HP-IB Addressing

The HP 8116A's HP-IB address is read from the address switch on the rear panel when the instrument is switched on. The address switch is set at the factory to 16 decimal.

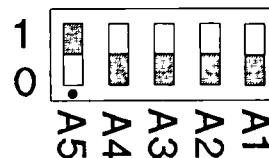

Figure 6-1. HP-IB Address Switch (Factory setting)

Note



- Pressing the **LCL** key displays the current address while the key is depressed.
- When allocating addresses ensure that no two instruments on the bus have the same address.

To change the instrument's address:

1. Change the address on the rear-panel address-switch.
2. Press the **(LCL)** key or switch the instrument off and on again.

Local, Remote and Local Lockout

Local mode

In this mode the RMT LED is off, the front panel is used to operate the instrument and programming messages are ignored.

You can select local mode in the following ways:

- Switching the HP 8116A on.
- Pressing the **(LCL)** key, if Local Lockout is inactive.
- Sending an HP-IB Local command to the instrument from the system controller (use the LOCAL statement in BASIC 5.0/5.1).

The output signal and all instrument settings remain unchanged following a change from remote to local mode.

Remote mode

In this mode the RMT LED is illuminated and programming messages received via the HP-IB are interpreted (parsed) and used to control the instrument. The front panel controls are disabled apart from:

- The **(LINE)** switch.
- The trigger LEVEL adjust knob.
- The **(LCL)** key, if Local Lockout is inactive.

You can select remote mode by sending an HP-IB Remote Enable command from the system controller (use the REMOTE statement in BASIC 5.0/5.1).

The output signal and all instrument settings remain unchanged following a change from local to remote mode.

Local Lockout

The **(LCL)** key can be disabled by sending an HP-IB Local Lockout command from the system controller (use the LOCAL LOCKOUT statement in BASIC 5.0/5.1). This ensures that only the system controller can return the instrument to Local mode, except if the instrument is switched off and on again.

It is recommended that all programming applications use this facility as, if a programming message is interrupted by pressing the **(LCL)** key during data transmission from the system controller, the HP 8116A may be left in an unknown state.

Introduction

Multiple programming commands can be put in a single programming message, for example:

```
OUTPUT 716;"M1,TO,FRQ 1 KHZ"
```

- It is not necessary to put a comma between commands, a space will do.
- The HP 8116A understands upper and lower case commands.
- Commands which change modes are processed before commands which set parameters, irrespective of the command order within the programming message. If your application requires a parameter change to occur before a mode change, use separate programming messages for the two commands.

The HP 8116A can be programmed into an error condition in the same ways as when using the front panel. For example, attempting to program a larger LOL than HIL:

```
OUTPUT 716;"HIL 1 V,LOL 2 V"
```

Refer to "Error, Fault and Status Reporting" for details of error, fault and status reporting using the HP-IB.

The HP 8116A needs time to interpret and implement the commands which it receives. You need to allow for this in your controller program. A summary of programming timings is given in "Message Interpretation times" in Chapter 2.

Selecting Trigger Modes

Standard Trigger Modes

Action	Mnemonic
Select NORM	M1
Select TRIG	M2
Select GATE	M3
Select E.WID	M4

Option 001 Trigger Modes

Action	Mnemonic
Select I.SWP	M5
Select E.SWP	M6
Select I.BUR	M7
Select E.BUR	M8

Trigger Control

Action	Mnemonic
Select trigger off	T0
Select positive trigger slope	T1
Select negative trigger slope	T2

Example `OUTPUT 716;"M3,T1"` *Select GATE mode with a positive trigger slope.*

Selecting Control Modes

Action	Mnemonic
Switch off control mode	CT0
Select FM	CT1
Select AM	CT2
Select PWM	CT3
Select VCO	CT4

Example `OUTPUT 716;"CT2"` *Select Amplitude Modulation.*

Selecting Output Waveform

Action	Mnemonic
Select DC	W0
Select sine	W1
Select triangle	W2
Select square	W3
Select pulse	W4
Select 0° (normal) startphase	H0
Select -90° startphase	H1

Example `OUTPUT 716;"W1,H0"` *Select sinewave output with 0° startphase.*

Setting Parameters

Note



A parameter's programming mnemonic is the same as its front panel description, AMP = amplitude for example.

Timing parameters

Action	Mnemonic	Value Delimiter
Set frequency	FRQ	MZ = millihertz HZ = hertz KHZ = kilohertz MHZ = megahertz
Set duty cycle	DTY	%
Set pulse width	WID	NS = nanoseconds US = microseconds MS = milliseconds

Example

OUTPUT 716;"FRQ 2.5 KHZ,DTY 30 %" *Set frequency to 2.5 kHz,
set duty cycle to 30%.*

Level parameters

Action	Mnemonic	Value Delimiter
Set amplitude	AMP	MV = millivolts V = volts
Set offset	OFS	MV = millivolts V = volts
Set high level	HIL	V = volts
Set low level	LOL	V = volts

Example

OUTPUT 716;"OFS -1 V,AMP 100 MV" *Set output offset to -1 V,
set amplitude to 100 mV.*

Option 001 Parameters

Action	Mnemonic	Value Delimiter
Set burst number	BUR	#
Set repeat interval	RPT	NS = nanoseconds US = microseconds MS = milliseconds
Set start frequency	STA	MZ = millihertz HZ = hertz KHZ = kilohertz MHZ = megahertz
Set stop frequency	STP	MZ = millihertz HZ = hertz KHZ = kilohertz MHZ = megahertz
Set marker frequency	MRK	MZ = millihertz HZ = hertz KHZ = kilohertz MHZ = megahertz
Set sweep time	SWT	MS = milliseconds S = seconds

Example

OUTPUT 716;"STA 2 KHZ,STP 100 KHZ,SWT 2 S" *Set up a start frequency of 2 kHz, a stop frequency 100 kHz and a sweeptime of 2 s.*

Autovernier

Note



Autovernier mode must be switched on before using the digit up/down commands.

Action	Mnemonic
Switch off autovernier	A0
Switch on autovernier	A1
Most significant digit up	MU
Second significant digit up	SU
Least significant digit up	LU
Most significant digit down	MD
Second significant digit down	SD
Least significant digit down	LD

Example

OUTPUT 716;"OFS 120 MV,A1,LU" *Set offset to 120 mV and increment in steps of 1mV.*

Reading parameters

It is possible to read the current setting of a parameter using the interrogation mnemonics listed here:

- Standard**
- IFRQ
 - IDTY
 - IWID
 - IAMP
 - IOFS
 - IHIL
 - ILOL

- Option 001**
- IBUR
 - IRPT
 - ISTA
 - ISTD
 - IMRK
 - ISWT

The IIP 8116A reply has the same format as that used when setting the parameter, for example:

```
FRQ 1.00KHZ
```

The reply length is always 12 characters.

It is also possible to read all the instrument settings in one go using the CST mnemonic. Refer to "Reading the Current Settings"

Example

```
DIM B$[12]           Allocate memory for reply.
OUTPUT 716;"IFRQ"    Request current frequency setting.
ENTER 716;B$        Read reply into allocated memory.
```

Selecting Output Modes

Output Controls

Action	Mnemonic
Switch off output limits	L0
Switch on output limits	L1
Switch off complementary output	C0
Complement output	C1
Enable output	D0
Disable output	D1

Example

OUTPUT 716;"L1,D0" *Switch on output limits and enable the output signal.*

Reading the Current Settings

The system controller can request the current instrument settings using the mnemonic **CST**.

The HP 8116A replies with a string containing all current settings. The data is always in the same order, but the level parameter data can be either **HIL/LOL** or **AMP/OFS** :

AMP and OFS active

```
M1,CTO,T1,W1,HO,AO,LO,CO,D1,BUR 001 #,RPT 100 MS,  
STA 1.00 KHZ,STP 100 KHZ,SWT 50.0 MS,MRK 1.00 KHZ,  
FRQ 1.00 KHZ,DTY 50 %,WID 100 US,AMP 1.00V,OFS 100 MV
```

HIL and LOL active

```
M1,CTO,T1,W1,HO,AO,LO,CO,D1,BUR 001 #,RPT 100 MS,  
STA 1.00 KHZ,STP 100 KHZ,SWT 50.0 MS,MRK 1.00 KHZ,  
FRQ 1.00 KHZ,DTY 50 %,WID 100 US,HIL 0.30 V,LOL -0.70 V
```

The examples shown are for an instrument with Option 001 fitted. In this case the maximum reply length is 161 characters, for a standard instrument the maximum reply length is 89 characters.

Example

```
DIM B$[161]           Allocate memory for maximum reply length  
OUTPUT 716;"CST"     Request current instrument settings  
ENTER 716;B$         Read reply into allocated memory
```

Timing

The time taken for the HP 8116A to receive and implement a programming message can be divided into three parts:

Data Transmission Time

This is the time taken to transmit the programming message over the HP-IB, which is 130 μ s per ASCII character. The system controller is free to continue with its program after this time.

Implementation Time

This is the time taken by the HP8116A to interpret and carry out all the commands in received message. Typical implementation times for various commands are given in the following table.

Table 6-1.

Command(s)	Implementation Time
Mode change	11 ms
W0 - W3	24 ms
W4	330 ms
FRQ	60 ms
DTY	60 ms
WID	24 ms
HIL	110 ms
LOL	100 ms
AMP	150 ms
OFS	150 ms
D0,D1,L0,L1,C0,C1	60 ms

The timings given are worst case. When parameter settings are combined into one programming message, the combined implementation time can be up to 40% more efficient.

The Buffer Not Empty flag in the HP 8116A status byte is set during this time. The system controller can therefore monitor this flag to detect when a programming message has been implemented. Refer to "Error, Fault and Status Reporting".

Hardware Settling Time

The hardware requires time to settle after a change. This takes longer than the interpretation time in some cases:

- When changing frequency, duty cycle, pulse width or amplitude, allow an additional 5 ms settling time.
- When changing offset or selecting DC output, allow an additional 30 ms settling time.

Error, Fault and Status Reporting

HP-IB Status Byte

The HP 8116A has an 8 bit status byte which can be read using a serial poll.

`A = SPOLL(716)` *Read instrument status byte into variable A*

The meaning of each bit in the status byte is given below. In all cases, the bit is set to 1 to indicate that the condition described is true.

Bit	Meaning
0	TIMING ERROR (Causes SRQ)
1	PROGRAMMING ERROR (Causes SRQ)
2	SYNTAX ERROR (Causes SRQ)
3	SYSTEM FAILURE (Causes SRQ)
4	AUTOVERNIER IN PROGRESS
5	SWEEP IN PROGRESS
6	SERVICE REQUEST (=SRQ)
7	BUFFER NOT EMPTY

The SRQ bit generates an interrupt at the system controller to indicate that the instrument requires attention. You can use this facility as the basis of interrupt driven error handling in your programming application.

The SRQ, Programming Error, Syntax Error and System Error bits are latched until the status byte is polled by the system controller. The other status bits represent the current condition at the time the status byte is read.

You can obtain more detailed information about timing and programming errors using the interrogate error (**IERR**) mnemonic. The HP 8116A responds with a string describing the current error conditions. The descriptions are covered in subsequent parts of this section.

```
DIM E$[45]                    Allocate memory for error string
OUTPUT 716;"IERR"            Request error information
ENTER 716:E$                 Read reply into allocated string
```

**Timing Error
(Bit 0)**

There are three (four with Opt 001) types of error which set the timing error bit in the status byte. The conditions which cause them and the description used by the HP 8116A when replying to an **IERR** command are listed below. The timing error bit is not latched, therefore a transient error is only recorded by generating an SRQ.

Note



More than one error condition can occur at one time. When using the **IERR** command ensure that you allow for a reply containing more than one error description.

IERR Description	Comments
WAVEFORM ERROR	<ul style="list-style-type: none">■ This error occurs if you request an invalid combination of trigger mode, control mode and waveform. Refer to Figure 4-5 for the permitted combinations.■ The front panel LEDs flash to indicate the invalid settings.■ The instrument's output is not affected.
DUTY C. ERROR	<ul style="list-style-type: none">■ This error occurs if you request an invalid combination of frequency and duty cycle. Refer to "Duty Cycle" in Chapter 2 for the valid combinations.■ The instrument's output is not affected.
WIDTH ERROR	<ul style="list-style-type: none">■ This error occurs if you request an invalid combination of frequency and pulse width so that: $WID > 1/FRQ$.■ The instrument's output changes.■ You can use the SR1 command to stop this error generating a timing error and an SRQ. To re-enable it, use the SR0 command. The response to IERR is not affected.
TIMING ERROR	<ul style="list-style-type: none">■ This error can only occur with Opt 001 in I.BUR mode.■ This error occurs if you request an invalid combination of frequency, burst number and repeat time so that: $BUR \times 1/FRQ > RPT$.■ The instrument's output changes.■ You can use the SR1 command to stop this error generating a timing error and an SRQ. To re-enable it, use the SR0 command. The response to IERR is not affected.

**Programming Error
(Bit 1)**

There are three types of error which cause the programming error bit in the status byte to be set. The following list gives the conditions which cause them and the description used by the HP 8116A when replying to an **IERR** command. The programming error bit is latched, therefore a transient error is recorded.

Note



It is possible to have more than one error condition at one time. Therefore, when using the **IERR** command ensure that you allow for a reply containing more than one error description.

IERR Description	Comments
HANDLING ERROR	This error occurs: <ul style="list-style-type: none">■ If you request autovernier mode when the instrument is not in NORM mode.■ If you attempt to leave NORM mode with autovernier mode active.■ If you attempt to set a timing parameter outside its specification limits.
LEVEL ERROR	<ul style="list-style-type: none">■ This error occurs if you attempt to set output level parameters outside their specification limits. Refer to Chapter 2 as two output ranges are used.■ The instrument's output is not affected.
LIMIT ERROR	<ul style="list-style-type: none">■ This can only occur if limited output mode is active.■ This error occurs if you attempt to set output level parameters outside the current limit levels.■ The instrument's output is not affected.

**Syntax Error
(Bit 2)**

This error occurs when the HP 8116A cannot understand a programming message. The bit is latched until cleared by reading the status byte.

**System Failure
(Bit 3)**

This error occurs when the HP 8116A fails its self-test. You can execute a self-test using the **EST** command:

```
OUTPUT 716:"EST"   Request a self-test
WAIT 3             Allow HP 8116A to execute self-test
A = SPOLL(716)     Read status byte in order to get result
```

The bit is latched until cleared by reading the status byte.

**Autovernier in Progress
(Bit 4)**

This bit is set during an autovernier.

**Sweep in Progress
(Bit 5)**

This bit is set during an output frequency sweep.

**Service Request
(Bit 6)**

This bit indicates that a service request has occurred. The bit is latched until cleared by reading the status byte.

**Buffer not Empty
(Bit 7)**

This bit is set when there is data in the HP 8116A's input buffer. You can monitor this bit to determine if the instrument has finished interpreting a long programming message.



HP-IB Universal Commands

The HP 8116A supports the following HP-IB Universal commands:

Note



These are HP-IB commands, NOT instrument programming commands. They are not used in programming messages. If you require more information on the HP-IB protocol and hardware refer to "General" for a list of references.

HP-IB Mnemonic	Description	BASIC 5.0/5.1 equivalent
DCL	Device Clear	CLEAR 7
SDC	Selected Device Clear	CLEAR 716
LLO	Local Lockout	LOCAL LOCKOUT 7
GTL	Go to Local	LOCAL 716 / LOCAL 7
GET	Group Execute Trigger	TRIGGER 716 / TRIGGER 7
UNL	Unlisten	SEND 716;UNL
UNT	Untalk	SEND 716,UNT
SPE	Serial Poll Enable	SPOLL(716)
SPD	Serial Poll Disable	

- DCL** An HP-IB DCL command causes the HP 8116A to load its standard parameter set. The instrument remains in its current mode (local or remote).
- SDC** An HP-IB SDC command causes the IIP 8116A to load its standard parameter set and enter remote mode.
- GET** An HP-IB GET command simulates an external trigger to the HP 8116A in TRIG, E.BUR and E.SWP modes.



Programming Examples

Introduction

The following examples are an introduction to programming the HP 8116A using BASIC 5.0/5.1 for the HP 9000 Series 200/300 controllers. The examples cover the following subjects:

- Testing communication with the HP 8116A.
- Performing the instrument's self-test.
- Using the Buffer not Empty flag.
- Using the autovernier.

Note



In the examples it is not strictly necessary to put the HP 8116A into remote mode using the REMOTE 716 command because:

- The CLEAR 716 statement used to initialise the instrument also selects remote mode.
- The OUTPUT statement itself selects remote mode.

However, the REMOTE statement is included for completeness.

Testing communication

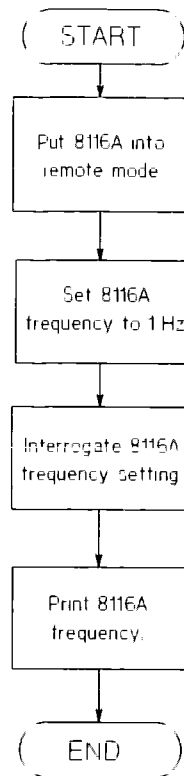

Programming applications should include an initial check that the HP 8116A is communicating correctly. A suitable quick check is to set a parameter to a particular value and then read it back, as illustrated by the flow chart and program example given here.

```

1      |                               Comments:
10     Adr=716                       !Device address of the HP 8116A
20     CLEAR Adr                      !Initialize Interface, set HP 8116A to
30     CLEAR SCREEN                   !Standard setting, and clear screen
40     A=SPOLL(Adr)                   !Clear the Status Byte
50     |
60     |           Program to check TALK/LISTEN FUNCTION
70     |
80     |                               (Visual Indicators)
90     |
100    REMOTE Adr                     !Enable Remote Control of HP 8116A
110    |                               (RMT LED on)
120    |
140    OUTPUT Adr;"FRQ 1 HZ"          !Set HP8116A frequency to 1 Hz
150    |                               (RMT and ADS LED's on,
160    |                               FRQ key LED on,
170    |                               '1.00 Hz' displayed)
180    OUTPUT Adr;"IFRQ"              !"Interrogate Frequency" command
200    |
210    ENTER Adr;A$                   !Input data from HP 8116A
220    |
250    PRINT A$                       !Print on screen
260    |                               (Printout " FRQ 1.00 HZ")
270    |
290    LOCAL Adr                      !Return HP 8116A to local operating mode
300    |
320    END

```

Performing self-test

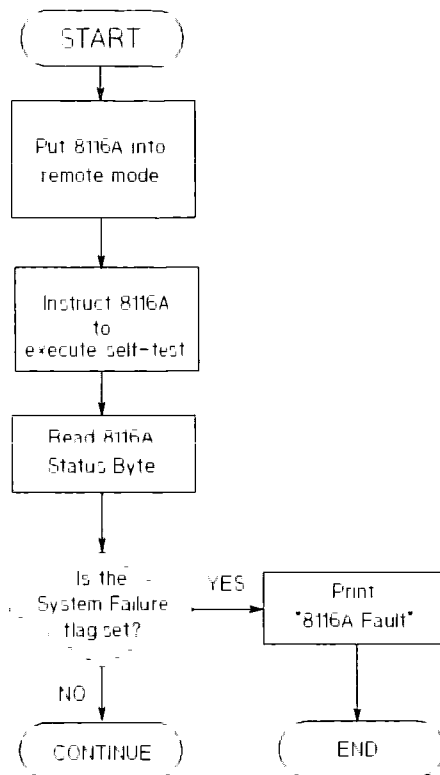

The HP 8116A RAM/Hardware self-test can be initiated via the HP-IB using the **EST** message. If a fault is detected, the HP 8116A sets the System Failure and Service Request bits in its HP-IB Status Byte. Refer to "Error, Fault and Status Reporting" in Chapter 6 for more information on the Status Byte.

```

1      !                               Comments:
10     Adr=716                         'Device address of the HP 8116A
20     CLEAR Adr                       'Initialize Interface, set HP 8116A to
25     !                               'Standard setting and remote mode
30     CLEAR SCREEN                    !
40     A=SPOLL(Adr)                   'Clear the Status Byte
50     !
60     !           Program to check RAM and HARDWARE
70     !
80     !                               (Visual Indicators)
100    REMOTE Adr                      'Enable Remote Control of HP 8116A
110    !                               (RMT LED on)
140    OUTPUT Adr;"EST"               'Execute Self Test" command
150    !                               (RMT and ADS LED's on)
160    WAIT 3                          'Time for HP 8116A internal processing
170    !
180    A=SPOLL(Adr)                   'Read and clear Status Byte
190    !
210    B=BIT(A,3)                     'Read bit 3 = System Failure Flag
220    !
230    IF B=1 THEN                    'If bit 3 is set, HP 8116A has a fault
240    !
250        PRINT "HP 8116A FAULT"      'Print fault message on screen
260    !
270    END IF
280    !
290    LOCAL Adr                      'Set HP 8116A to local operating mode
300    !
310    END

```

HP 8116A Self-test

Using the Buffer Not Empty Flag

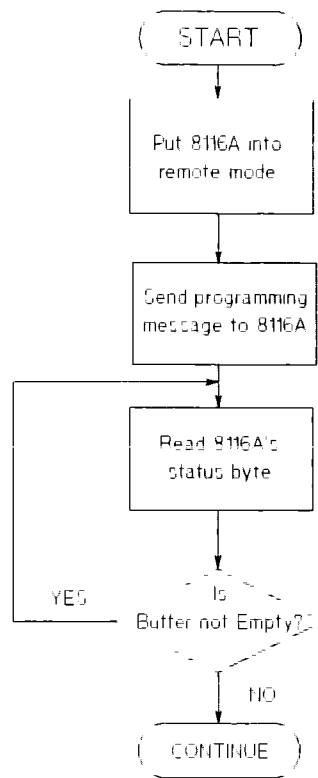

The Buffer Not Empty flag indicates that the HP 8116A is currently interpreting a programming message. You can use the flag to make the system controller wait until a message has been implemented before proceeding. This is an alternative to using the WAIT statement with a fixed delay.

```

10      |
20      Adr=716
30      CLEAR Adr
40      |
50      CLEAR SCREEN
60      A=SPOLL(Adr)
60      |
70      OUTPUT Adr;"M2,T1,W2,FRQ 10 KHZ,AMP 1 V,OFS 1 V"
80      |
90      |
100     |
110     |
130     REPEAT
140         A=SPOLL(716)
150     UNTIL BIT(A,7)=0
160     |
170     |
180     LOCAL Adr
190     |
200     |
210     END

```

Comments:

'Address of the HP 8116A

'Initialize interface, set HP 8116A to

'standard setting and remote mode

'Clear the status byte

'Select trigger mode with triggering on

'positive slope, triangle signal output

'and change frequency, amplitude and offset

'Keep polling the HP 8116A status byte

'until Buffer Not Empty flag returns to

'zero indicating the command message has

'been implemented

'Return HP 8116A to local mode

Using the Autovernier

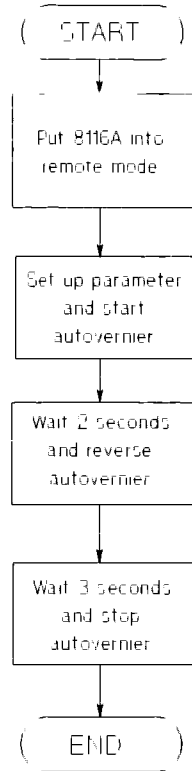

The autovernier function is fully programmable, however, the digit up/down commands will cause a syntax error if they are used without autovernier mode switched on. The example shows an autovernier over fixed time intervals. You can also monitor the Autovernier in Progress bit in the status byte to allow an autovernier to continue until the parameter limits are reached.

```

10      !                               Comments:
20      Adr=716                         !Address of the HP 8116A
30      CLEAR Adr                       !Initialize interface, set HP 8116A to
40      !                               !standard setting and remote mode
50      CLEAR SCREEN
60      A=SPOLL(Adr)                    !Clear the status byte
70      !
80      OUTPUT Adr;"D0"                 !Enable the HP 8116A's output
90      !
100     !
110     OUTPUT Adr;"OFS 100 MV,A1,SU"   !Set offset to 100 mV and start
120     !                               !autovernier upwards in steps of 10 mV
130     !
140     WAIT 2
150     !
160     !
170     OUTPUT Adr;"SD"                 !After 2 seconds, decrement in 10mV
180     !                               !steps from the current offset
190     !
200     WAIT 3
210     !
220     !
230     OUTPUT Adr;"A0"                 !After another 3 seconds, stop
240     !                               !autovernier function
250     !
260     LOCAL Adr                       !Return to local mode
270     !
280     !
290     END

```

Index

- A** A0 - A1, 6-8
AM, 4-8
AMP, 4-12, 6-6
Autovernier
 - Operating, 4-14
 - Programming, 6-8
 - Status, 6-16

- B** BUR, 4-12, 6-7

- C** C0 - C1, 6-10
Control mode
 - AM, 4-8
 - FM, 4-8
 - Programming, 6-5
 - PWM, 4-9
 - Selecting, 4-7
 - VCO, 4-10CST, 6-11
CT0 - CT4, 6-5

- D** D0 - D1, 6-10
DCL, 6-17
DTY, 4-12, 6-6

- E** Error
 - Programming, 6-15
 - reporting, 6-13
 - Syntax, 6-15
 - Timing, 6-14External Trigger Controls, 4-6

- F** Fault reporting, 6-13
FM, 4-8
FRQ, 4-12, 6-6

- G** GET, 6-17
GTL, 6-17

- H** H0 - H1, 6-5
HIL, 4-12, 6-6
Hold Input, 4-17
HP-IB
 - Address, 4-16, 6-1
 - Status byte, 6-13
 - Universal commands, 6-17

- I** IERR, 6-13, 6-14, 6-15

- K** Keys
 - 1 CYCLE**, 4-6
 - 90°**, 4-11
 - AUTO**, 4-14
 - COMPL**, 4-15
 - DISABLE**, 4-15
 - LCL**, 6-2
 - LIMIT**, 4-15
 - MAN**, 4-6
 - VERNIER**, 4-13

- L** L0 - L1, 6-10
LD, 6-8
LLO, 6-17
Local lockout, 6-2
Local mode, 6-2
LOL, 4-12, 6-6
LU, 6-8

- M** M1 - M8, 6-4
Marker Output, 4-17
MD, 6-8
MRK, 4-12, 6-7
MU, 6-8

- O** OFS, 4-12, 6-6
Operation, 4-1
Output mode
 - Programming, 6-10
 - Selecting, 4-15

- P** Parameter
 - Programming, 6-6
 - Reading, 6-9, 6-11
 - Setting, 4-12
- Performance Tests, 8-1
- Power on, 4-2
- Programming, 6-1
 - Examples, 7-1
- Programming error, 6-15
- PWM, 4-9

- R** Remote mode, 6-2
- RPT, 4-12, 6-7

- S** SD, 6-8
- SDC, 6-17
- SPD, 6-17
- SPE, 6-17
- SRQ, 6-13, 6-16
- STA, 4-12, 6-7
- Standard Parameter Set, 4-3
- Status byte, 6-13
- Status reporting, 6-13
- STP, 4-12, 6-7
- SU, 6-8
- Switching on, 4-2
- SWT, 4-12, 6-7
- Syntax error, 6-15
- System Failure, 6-15

- T** T1 - T3, 6-4
- Test
 - Self-test, 4-2, 6-15
- Testing
 - Self-test, 7-4
- Timing error, 6-14
- Trigger Controls, 4-6
- Trigger mode
 - Programming, 6-4
 - Selecting, 4-4
- Trigger Output, 4-6

- U** UNL, 6-17
- UNT, 6-17

- V** VCO, 4-10
Verification Tests, 8-1

- W** W0 - W4, 6-5
Waveform
 programming, 6-5
 selecting, 4-11
WID, 4-12, 6-6

- X** X-Output, 4-17

Testing Performance

Introduction

This chapter lists a number of test procedures designed to test the electrical performance of the HP 8116A against the Specifications and Operating Characteristics given in Chapter 2. The tests are in two groups, Performance tests which check warranted Specifications and Verification tests which verify Operating Characteristics.

Performance Tests

- Frequency
- Duty Cycle
- Pulse Width
- Amplitude & Offset
- Sine waveform
- Pulse/Squarewave waveform -
- DC output

Verification Tests

- Trigger, Gate and External Width modes
- Burst modes (Opt 001)
- Frequency Modulation
- Amplitude Modulation
- Pulse Width Modulation
- Sweep modes (Opt 001)
- Autovernier and Output modes
- IIP-IB programming

The tests can be used for incoming inspection, troubleshooting or preventative maintenance. Note that to prove that the instrument is within specification, only the Performance Tests have to be carried out. The test results can be recorded on a copy of the Test Records which follow the test procedures. Test results recorded at incoming inspection can be used for comparison after carrying out maintenance, repair or adjustments.

The tests must be performed with the HP 8116A in its normal operating condition, that is, with all shields, connections and the case in place.

Test Equipment

Refer to Table 1-1 and Table 1-2 for the recommended test equipment.

Test Record

Equipment Test Records are provided at the end of this chapter. Make a copy in order to record your test results.

Frequency Performance Test

Specifications

Range

1.00 mHz to 50.0 MHz

Accuracy

Frequency (FRQ)	Pulse mode or waveforms with 50% duty cycle	Waveforms with duty cycle \neq 50%
$1 \text{ mHz} \leq \text{FRQ} < 100 \text{ kHz}$	$\pm 3\% \pm 0.3 \text{ mHz}$	$\pm 3\% \pm 0.6 \text{ mHz}$
$100 \text{ kHz} \leq \text{FRQ} < 10 \text{ MHz}$	$\pm 5\%$	$\pm 10\%$
$10 \text{ MHz} \leq \text{FRQ} \leq 50 \text{ MHz}$	$\pm 5\%$	n/a

Test Setup

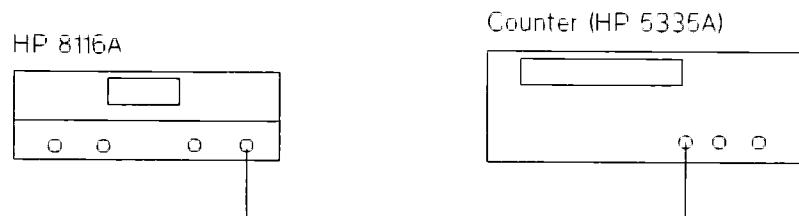

Figure 8-1. Frequency Performance Test

Equipment

- Counter (HP 5335A)
- Cable Assembly BNC
- 50 Ω Feedthrough Termination
(Required if counter input impedance \neq 50 Ω)

Procedure

1. Connect the equipment as shown in the setup figure. Use a 50 Ω feedthrough termination if you cannot select 50 Ω input impedance on the counter.
2. Set up the HP 8116A as follows:
Trigger Mode NORM
Control Mode Off
Waveform Square
Complement Output Off
DTY 50%
AMP 1 V
OFS 0 V
3. Set the counter to measure frequency.
4. Set the HP 8116A's frequency to the following values and read the actual output frequency from the counter. Record your results on a copy of the Test Record, specified limits are given here and on the Test Record.

HP 8116A setting	Counter reading
50.0 MHz	50.0000 MHz ± 2.500 MHz
10.0 MHz	10.0000 MHz ± 0.500 MHz
10.0 kHz	10.0000 kHz ± 0.300 kHz
1.0 kHz	1.00000 kHz ± 0.30 kHz

5. Set the counter to measure period.
6. Set the HP 8116A's frequency to the following values and read the actual period from the counter. Record your results on a copy of the Test Record, specified limits are given here and on the Test Record.

HP 8116A setting	Counter reading
1.00 Hz	1.00000 s ± 0.0333 s
100 mHz	10.0000 s ± 0.333 s

Duty Cycle Performance Test

Specifications

Frequency (FRQ)	Range and Resolution	Accuracy
$1 \text{ mHz} \leq \text{FRQ} < 1 \text{ MHz}$	10% to 90% in steps of 1%	$\pm 0.5 \text{ LSD}^*$
$1 \text{ MHz} \leq \text{FRQ} < 10 \text{ MHz}$	20% to 80% in steps of 1%	$\pm 3.0 \text{ LSD}$
$10 \text{ MHz} \leq \text{FRQ} \leq 50 \text{ MHz}$	50% fixed	$\pm 5.0 \text{ LSD, typical}$

*Least Significant Digit (only units and tens are displayed)

Test Setup

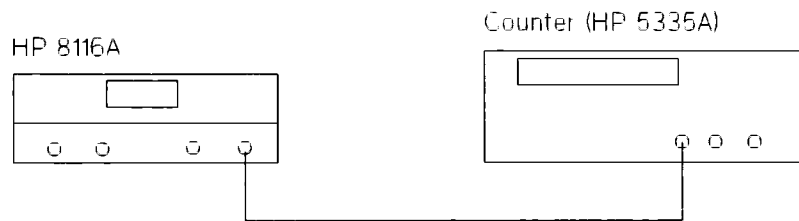

Figure 8-2. Duty Cycle Performance Test

Equipment

- Counter (HP 5335A)
- Cable Assembly BNC
- 50 Ω Feedthrough Termination
(Required if counter input impedance $\neq 50 \Omega$)

Procedure

1. Connect the equipment as shown in the setup figure. Use a 50 Ω feedthrough termination if you cannot select 50 Ω input impedance on the counter.
2. Set up the HP 8116A as follows:
Trigger Mode NORM
Control Mode Off
Waveform Square
Complement Output Off
AMP 1 V
OFS 0 V
3. Set the counter to read duty cycle.
4. Set the HP 8116A's frequency and duty cycle to the values given here, and read the actual duty cycle from the counter. Record your results on a copy of the Test Record, specified limits are given here and on the Test Record.

HP 8116A frequency	HP 8116A Duty cycle	Counter reading
1 Hz	10%	9.5% to 10.5%
	50%	49.5% to 50.5%
	90%	89.5% to 90.5%
1 kHz	10%	9.5% to 10.5%
	50%	49.5% to 50.5%
	90%	89.5% to 90.5%
9.99 MHz	20%	17.0% to 23.0%
	50%	47.0% to 53.0%
	80%	77.0% to 83.0%

Pulse Width Performance Test

Specification

Range

10.0 ns to 999 ms
(Maximum = $1/\text{FRQ} - 10 \text{ ns}$)

Accuracy

$\pm 5\% \pm 2 \text{ ns}$

Test Setup

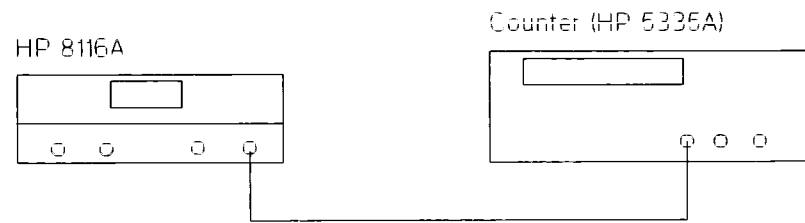

Figure 8-3. Pulse Width Performance Test - Stage 1

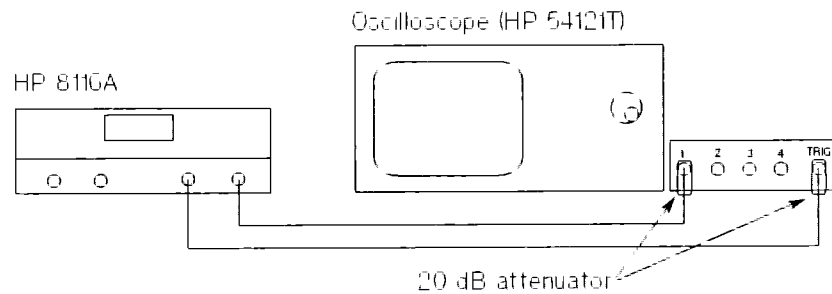

Figure 8-4. Pulse Width Performance Test - Stage 2

Equipment

- Counter (HP 5335A)
- Cable Assembly BNC (2 ×)
- Digitizing Oscilloscope (HP 54121T)
- Attenuator 20 dB, 2 W. (2 ×)
- 50 Ω Feedthrough Termination
(Required if counter input impedance $\neq 50 \Omega$)

Procedure

1. Connect the HP 8116A and counter as shown in Figure 8-3.
2. Set up the HP 8116A as follows:

Trigger Mode	NORM
Control Mode	Off
Waveform	Pulse
FRQ	1 MHz
AMP	1 V
OFS	0 V
3. Set counter to **TIME A→B, COMA f, B \, Trig level 0 V.**
4. Set the HP 8116A's frequency and pulse width to the values given here and read the actual pulse width from the counter. Record your results on a copy of the Test Record, specified limits are given here and on the Test Record.

HP 8116A Frequency	HP 8116A Width	Counter reading
1 MHz	100 ns	93 ns to 107 ns
100 kHz	1 μ s	948 ns to 1052 ns
1 kHz	100 μ s	95 μ s to 105 μ s
10 Hz	1 ms	950 μ s to 1050 μ s
1 Hz	500 ms	475 ms to 525 ms

5. Connect the HP 8116A and oscilloscope as shown in Figure 8-4.
6. Set up the HP 8116A as follows:

FRQ	10.0 MHz
WID	8.0 ns
7. Adjust the oscilloscope to show one cycle on the display.

Note

Pulse width is measured at 50% of pulse amplitude.

8. Verify that the pulse width is ≤ 10 ns, and record the actual pulse width on your Test Record.

Amplitude & Offset Performance Test

Specification Amplitude and offset are independently variable within the following two level windows:

Level window:	± 800 mV	± 8.00 V
Amplitude range	10.0 mV to 99.9 mV (p-p)	100 mV to 16.0 V (p-p)
Amplitude resolution	3 digits (best case 0.1 mV)	3 digits (best case 1 mV)
Amplitude accuracy	$\pm 5\%$	$\pm 5\%$
Offset range	0 to ± 795 mV	0 to ± 7.95 V
Offset resolution	3 digits (best case 0.1 mV)	3 digits (best case 1 mV)
Offset accuracy	$\pm 1\%$ of programmed value $\pm 1\%$ of amplitude ± 4 mV	$\pm 0.5\%$ of programmed value $\pm 1\%$ of amplitude ± 40 mV
Repeatability	Factor 4 better than accuracy	

Test Setup

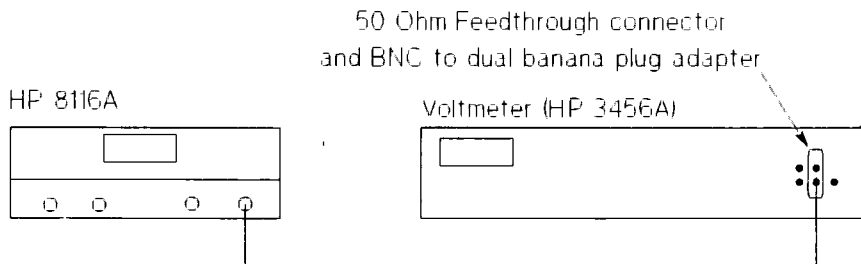

Figure 8-5. Amplitude & Offset Performance Test

- Equipment**
- Digital Voltmeter (HP 3456A)
 - Cable Assembly BNC
 - 50 Ω Feedthrough Termination (1% accuracy)
 - BNC to Dual Banana plug adapter

Procedure

1. Connect the equipment as shown in the setup figure.
2. Set up the HP 8116A as follows:

Trigger Mode	NORM
Control Mode	Off
Waveform	Sine
Complement Output	Off
FRQ	1 kHz
DTY	50%
OFS	0 V
3. Set the voltmeter to measure ac voltage (RMS).
4. Set the HP 8116A's amplitude to the values given here. For each value, vary the output waveform and read the RMS output voltage from the voltmeter. Record your results on a copy of the Test Record, specified limits are given here and on the Test Record.

HP 8116A Amplitude	HP 8116A Offset	HP 8116A Waveform	Voltmeter reading
8.00 V	0 mV	Sine	2.69 to 2.97 V
		Triangle	2.19 to 2.43 V
		Square	3.8 to 4.2 V
3.00 V	0 mV	Sine	1.008 to 1.114 V
		Triangle	0.823 to 0.909 V
		Square	1.425 to 1.575 V
1.00 V	0 mV	Sine	0.336 to 0.372 V
		Triangle	0.275 to 0.303 V
		Square	0.475 to 0.525 V
100 mV	0 mV	Sine	33.6 to 37.1 mV
		Triangle	27.4 to 30.3 mV
		Square	47.5 to 52.5 mV

5. Set the voltmeter to read dc voltage.
6. For amplitudes of 100 mV and 10 mV, vary the offset through the values given here and read the output voltage from the voltmeter. Record your results on a copy of the Test Record, specified limits are given here and on the Test Record.

HP 8116A Amplitude	HP 8116A Offset	Voltmeter reading
100 mV	7.50 V	7.421 to 7.587 V
	5.00 V	4.934 to 5.066 V
	3.00 V	2.944 to 3.056 V
	1.00 V	0.954 to 1.046 V
	100 mV	58 to 142 mV
10 mV	795 mV	783 to 807 mV
	500 mV	491 to 509 mV
	100 mV	95 to 105 mV

Sine Waveform Performance Test

Specification

The following specifications apply for normal output mode and 50% duty cycle.

Total Harmonic Distortion (THD) < 1% (-40 dB), (10 Hz to 50 kHz).
This may increase by 3 dB below 10°C.

Harmonic signals < 2% (-34 dBc*)
for $50 \text{ kHz} \leq \text{FRQ} < 1 \text{ MHz}$

< 7% (-23 dBc*)
for $\text{FRQ} \geq 1 \text{ MHz}$
and amplitude < 8 V (p-p)

* dBc = dB relative to carrier (fundamental).

Test Setup

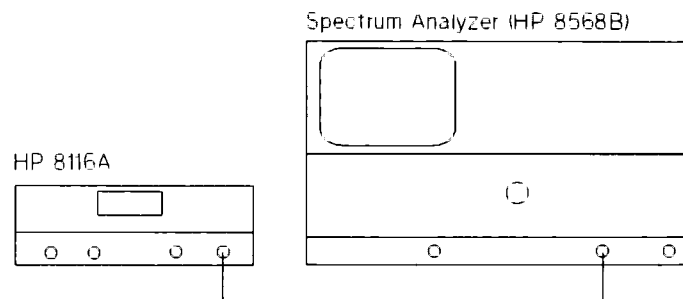

Figure 8-6. Sine Waveform Performance Test

Equipment

- HF Spectrum Analyzer (HP 8568B)
- Cable Assembly BNC
- BNC to Type N Adapter

Procedure

1. Connect the equipment as shown in the setup figure
2. Set up the HP 8116A as follows:

Trigger Mode	NORM
Control Mode	Off
Waveform	Sine
Complement Output	Off
FRQ	1 kHz
DTY	50%
AMP	8 V
OFS	0 V
3. Adjust the spectrum-analyzer frequency sweep to cover the range 500 Hz to 30 kHz.
4. Adjust the gain so that the fundamental (1 kHz) corresponds to 0 dB.
5. If necessary, adjust the frequency sweep again so that all harmonics ≥ -60 dB are shown.
6. Calculate the Total Harmonic Distortion according to the following formula:

$$THD\% = 100 \times \sqrt{10^{\frac{A_1}{10}} + 10^{\frac{A_2}{10}} + 10^{\frac{A_3}{10}} + \dots}$$

Note



- A_1 = level of second harmonic in dB.
- Ignore all harmonics at levels ≤ -60 dB.

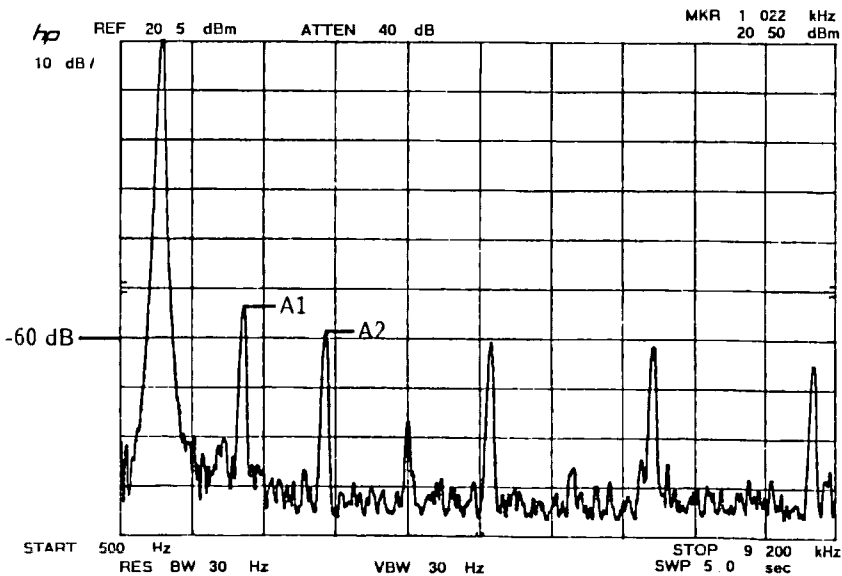

Figure 8-7. Typical Spectrum Analyzer display at 1 kHz.

7. Record the THD on the Test Record.

8. Set the HP 8116A frequency to 50 MHz.
9. Adjust the spectrum-analyzer frequency sweep to cover the range 10 MHz to 350 MHz.
10. Adjust the gain so that the fundamental (50 MHz) corresponds to 0 dB.
11. Check that no harmonics exceed -23 dB. Record the level of the worst harmonic on the Test Record.

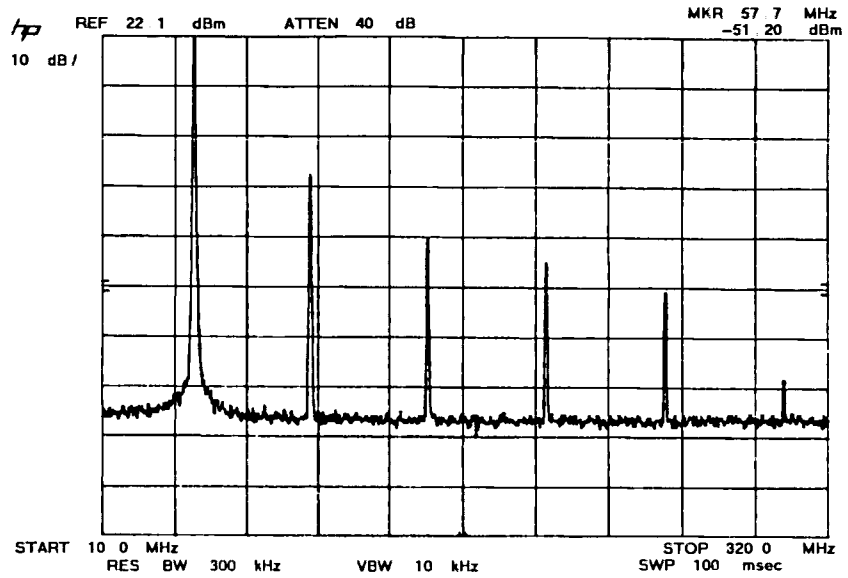

Figure 8-8. Typical Spectrum Analyzer display at 50 MHz.

Pulse/Squarewave Performance Test

Specification

Transition time < 7 ns (10% to 90% of amplitude)

Pulse perturbations < $\pm 5\%$ of amplitude ± 2 mV

Test Setup

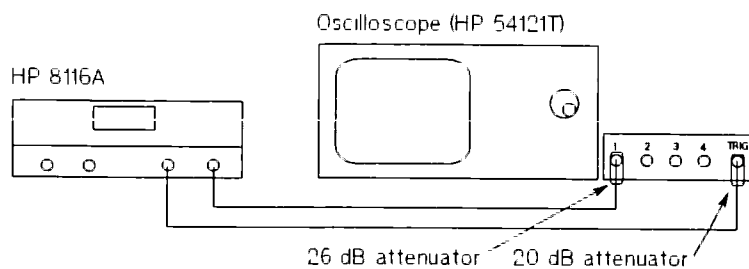

Figure 8-9. Pulse/Squarewave Performance Test

- Equipment**
- Digital Oscilloscope (HP 54121T)
 - Cable Assembly BNC (2 ×)
 - Attenuator 20 dB, 2 W (2 ×)
 - Attenuator 6 dB, 2 W

Procedure

1. Connect the equipment as shown in the setup figure
2. Set up the HP 8116A as follows:

Trigger Mode	NORM
Control Mode	Off
Waveform	Square
Complement Output	Off
FRQ	1 MHz
DTY	50%
AMP	8 V
OFS	0 V
3. Adjust the oscilloscope so that one cycle fills the display.
4. Measure the following characteristics and record the results on the Test Record:

Note

- Transition times, rise and fall, are measured between 10% and 90% of amplitude.
- Sampling error may affect the measurement of pre- and overshoot.

Characteristic	Specification
Risetime (leading edge)	≤ 7 ns
Falltime (trailing edge)	≤ 7 ns
Preshoot	$\leq \pm 5\%$ of amplitude
Overshoot/Ringing	$\leq \pm 5\%$ of amplitude

DC Output Performance Test

Specification

Range	0 mV to ± 7.95 V
Resolution	3 digits, best case 1mV
Accuracy	$\pm 0.5\% \pm 40$ mV
Repeatability	Factor 4 better than accuracy

Test Setup

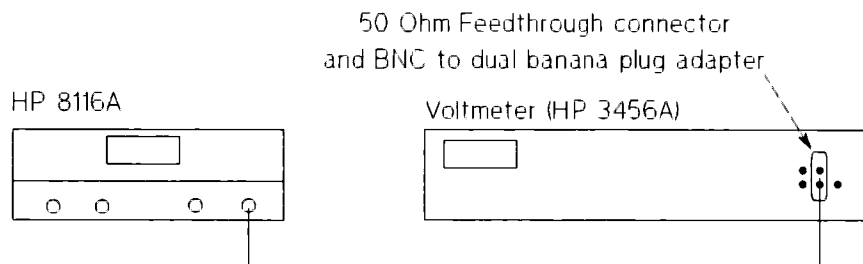

Figure 8-10. DC Output Performance Test

- Equipment**
- Digital Voltmeter (HP 3456A)
 - Cable Assembly BNC
 - 50 Ω Feedthrough Terminator.

Procedure

1. Connect the equipment as shown in the setup figure
2. Set up the HP 8116A as follows:
Trigger Mode NORM
Control Mode Off
Waveform Off
Complement Output Off
AMP 100 mV
3. With the amplitude fixed at 100 mV, vary the offset through the values given here and read the output voltage from the voltmeter. Record your results on a copy of the Test Record, specified limits are given here and on the Test Record.

HP 8116A Offset	Voltmeter reading
+7.95 V	+7.890 to 8.010 V
+5.00 V	+4.955 to 5.045 V
+2.00 V	+1.970 to 2.030 V
0.00 V	-0.020 to +0.020 V
-2.00 V	-2.030 to -1.970 V
-5.00 V	-5.045 to -4.955 V
-7.95 V	-8.010 to -7.890 V

Trigger, Gate and External Width Verification Test

Characteristics

Trigger

Minimum amplitude 500 mV (p-p)

Minimum pulse width 10 ns

Generates one output cycle.

Gate

- External signal enables output.
- First output cycle synchronous with external trigger.
- Last output cycle always completed.

External Width

In pulse waveform only, the external signal is used to determine the output pulse width.

Test Setup

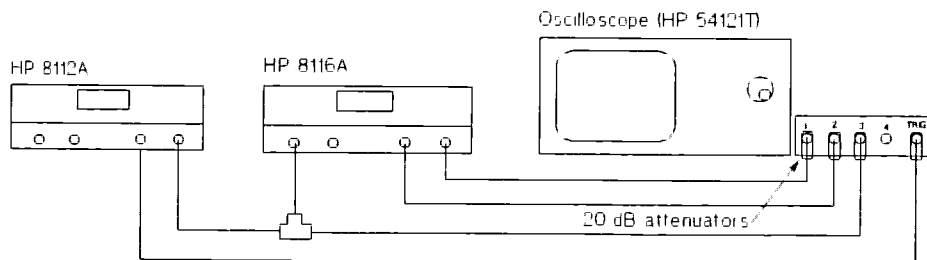

Figure 8-11. Trigger, Gate & External Width Performance Test

- Equipment**
- Pulse generator (HP 8112A)
 - Oscilloscope (HP 54121T)
 - Attenuator 20 dB, 2 W (4 ×)
 - Cable Assembly BNC (5 ×)
 - BNC T-connector

Procedure

1. Connect the equipment as shown in the setup figure

2. Set up the HP 8116A as follows:

Trigger Mode	TRIG
Trigger Slope	f
Control Mode	Off
Waveform	Sine
Complement Output	Off
FRQ	60 kHz
DTY	50%
AMP	1 V
OFS	0 V

3. Set up the external pulse generator as follows:

Pulse Width	50 μ s
Period	100 μ s
Output low level	0 V
Output high level	1 V

4. Using the oscilloscope, adjust the HP 8116A trigger level to allow triggering from the external pulse generator.

5. Verify that each external trigger pulse generates one complete output cycle as shown here:

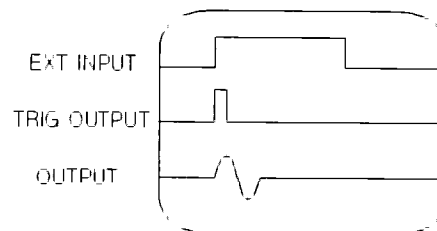

6. Set the HP 8116A to GATE trigger mode. Verify that the external signal enables output cycles and that each cycle is complete, as shown here:

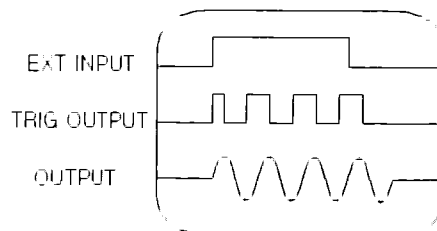

- Set the HP 8116A to E.WID trigger mode and pulse waveform. Verify that the external pulse triggers an output pulse of the same width, as shown here:

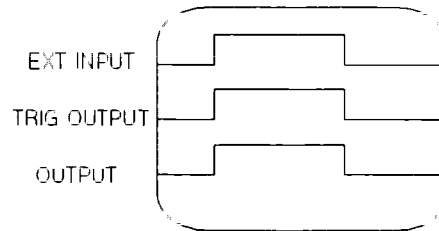

Burst Modes Verification Test (Opt 001)

- Characteristics**
- Internal burst:** Output bursts are repeatedly generated at programmable time intervals in the range 100 ns to 999 ms. This mode is not available in pulse waveform mode.
 - External burst:** An output burst is triggered by the external signal. The minimum time between burst triggers is 100 ns.

Test Setup

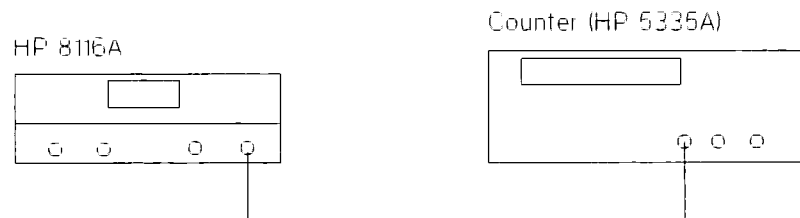

Figure 8-12. Burst Modes Verification Test

- Equipment**
- Counter (HP 5335A)
 - Cable Assembly BNC
 - 50 Ω Feedthrough Termination
(Required if counter input impedance \neq 50 Ω)

Procedure

1. Connect the equipment as shown in the setup figure. Use a 50 Ω feedthrough termination if you cannot select 50 Ω input impedance on the counter.
2. Set up the HP 8116A as follows:

Trigger Mode	E.BUR
Control Mode	Off
Waveform	Square
Complement Output	Off
FRQ	10 kHz
DTY	50%
AMP	1 V
OFS	0 V
BUR	816
3. Set the counter to **TOT A** and manual Gate mode.
4. Reset the counter and enable the gate.
5. Simulate an external trigger to the HP 8116A by pressing the **MAN** key and verify that the counter counts 816 output cycles.

Frequency Modulation Verification Test

Characteristics	Deviation	$\pm 5\%$ maximum for ± 6 V input
	Modulation bandwidth	dc to 20 kHz (FRQ < 10 MHz) dc to 3 kHz (FRQ \geq 10 MHz)

Test Setup

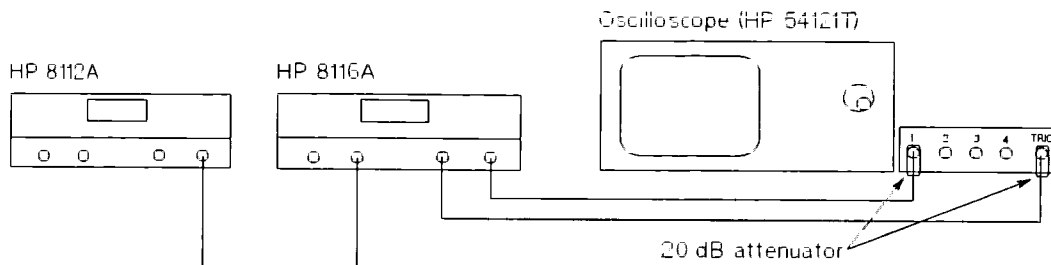

Figure 8-13. Frequency Modulation Verification Test

- Equipment**
- Pulse Generator (HP 8112A)
 - Oscilloscope (HP 54121T)
 - Cable Assembly BNC (3 x)
 - Attenuator 20 dB, 2 W (2 x)

Procedure

1. Connect the equipment as shown in the setup figure

2. Set up the HP 8116A as follows:

Trigger Mode	NORM
Control Mode	FM
Waveform	Square
Complement Output	Off
FRQ	1 MHz
DTY	50%
AMP	1 V
OFS	0 V

3. Set up the pulse generator as follows:

Pulse Width	50 μ s
Period	100 μ s
Output low level	-1 V
Output high level	1 V

4. Set the oscilloscope's timebase to 10 ns/div.

5. Measure the edge jitter caused by the modulation and record it on the Test Record. The jitter is typically 2 div \pm 10%.

Amplitude Modulation Verification Test

Characteristics	Modulation	100% with ± 2.5 V input DSBSC (Double Side Band Suppressed Carrier) with +2.5 V, -7.5 V input
	Modulation bandwidth	dc to 1 MHz
	Envelope distortion	< 1% for modulation depth < 90% (dc to 50 kHz and not complementary output)

Test Setup

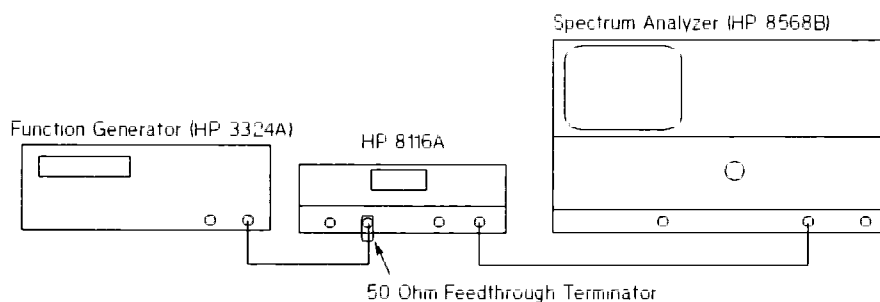

Figure 8-14. Amplitude Modulation Verification Test

- Equipment**
- Function Generator (HP 3324A)
 - Spectrum Analyzer (HP 8568B)
 - Cable Assembly BNC (2 ×)
 - Feedthrough Termination 50 Ω

Procedure

1. Connect the equipment as shown in the setup figure

2. Set up the HP 8116A as follows:

Trigger Mode	NORM
Control Mode	AM
Waveform	Sine
Complement Output	Off
FRQ	15 kHz
DTY	50%
AMP	1 V
OFS	0 V

3. Set up the function generator as follows:

Waveform	Sine
Frequency	2 kHz
Amplitude	4.5 V
Offset	0 V

4. Adjust the spectrum-analyzer frequency range to display the 15 kHz carrier, the sidebands and the harmonics of the sidebands.

5. Adjust the gain so that the carrier level is 0 dB.

6. Verify that all sideband harmonics are at least 42 dB lower than the sidebands, and record the level of the worst harmonic on the Test Record.

Pulse Width Modulation Verification Test

Characteristics	Modulation range	Maximum of one decade with ± 6.5 V input
	Pulse width ranges	10 ns to 1 s in eight adjacent decade ranges

Test Setup

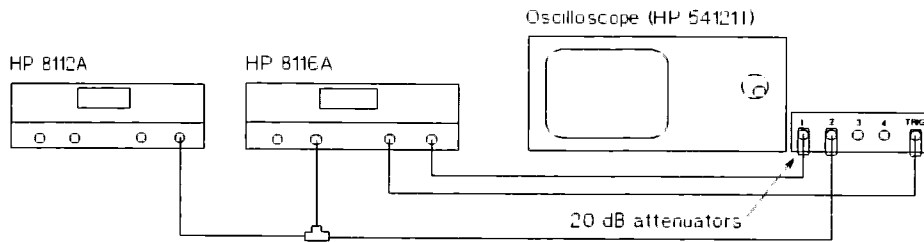

Figure 8-15. Pulse Width Modulation Verification Test

- Equipment**
- Pulse Generator (HP 8112A)
 - Oscilloscope (HP 54121T)
 - Attenuator 20 dB, 2 W (3 x)
 - Cable Assembly BNC (5 x)
 - BNC T connector

Procedure

1. Connect the equipment as shown in the setup figure

2. Set up the HP 8116A as follows:

Trigger Mode	NORM
Control Mode	PWM
Waveform	Pulse
Complement Output	Off
HIL	1 V
LOL	0 V

3. Set up the pulse generator as follows:

Width	500 ms
Period	999 ms
Low output level	-6 V
High output level	6 V

4. Set the HP 8116A frequency and width range to the values given in the following table, and use the oscilloscope to verify that the pulse width varies between the minimum and maximum limits.

Note

The HP 8116A displays the pulse width value corresponding to a 0 V control input signal for the chosen decade range. For example, 550 ns width indicates a pulse width range of 100 ns to 1.0 μ s. Use the range key to change the pulse width range.

HP 8116A Frequency	HP 8116A Width Range	Minimum width	Maximum width
1 MHz	55 ns	10 ns	100 ns
100 kHz	550 ns	100 ns	1.0 μ s
1 kHz	55 μ s	10 μ s	100 μ s

Sweep Modes Verification Test (Opt 001)

Characteristics For all waveforms the output signal frequency performs a logarithmic sweep between selected start and stop frequencies within the instrument's range (1 mHz to 50 MHz). The sweep time per decade is selectable between 10 ms and 500 s but restricted to intervals in the ratios 1:2:5. The sweep always starts with 0° output phase.

Test Setup

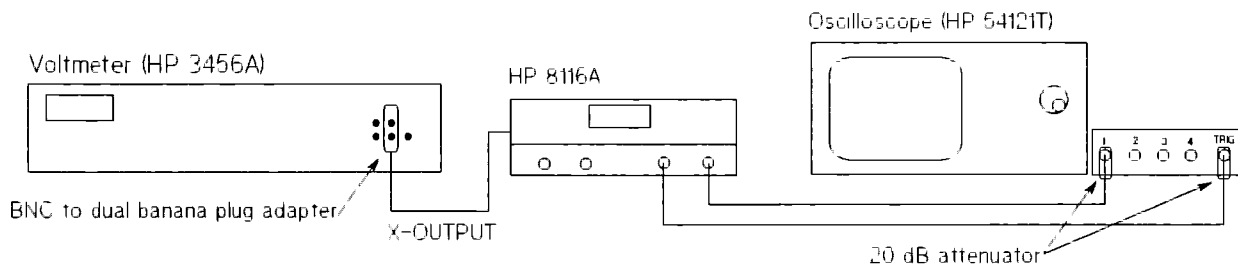

Figure 8-16. Sweep Mode Verification Test

- Equipment**
- Oscilloscope (HP 54121T)
 - Attenuator 20 dB, 2 W (2 ×)
 - Digital Voltmeter (HP 3456A)
 - Cable Assembly BNC (3 ×)

Procedure

1. Connect the equipment as shown in the setup figure
2. Set up the HP 8116A as follows:

Trigger Mode	E SWP
Control Mode	Off
Waveform	Sine
Complement Output	Off
STA	10 kHz
STP	10 MHz
SWT	2 s/decade
MRK	1.0 MHz
AMP	1 V
OFS	0 V
3. Set the voltmeter to read DC volts.
4. Adjust the oscilloscope timebase to 50 μ s/division.
5. Verify that the HP 8116A output signal displayed on the oscilloscope is 10 kHz.
6. After pressing the **MAN** key to simulate an external trigger, confirm that:
 - a. the HP 8116A displays IP, meaning sweep in progress.
 - b. the frequency of the output signal increases.
 - c. the level of the X-OUTPUT shown on the voltmeter gradually rises from 0 V to 4.5 V during the sweep time (6 seconds).
7. At the end of the sweep adjust the oscilloscope timebase to 50 ns/division and verify that the HP 8116A output signal is 10 MHz.
8. Disconnect the X-OUTPUT from the voltmeter and connect the MARKER OUTPUT in its place.
9. Press the **MAN** key to return to the start frequency.
10. After pressing the **MAN** key again, verify that the MARKER OUTPUT switches when the marker frequency (1 MHz) is reached (4 seconds after the sweep is initiated).
11. Select ISWP mode on the HP 8116A.
12. Verify that the sweep is running with the same parameters as before.

Autovernier and Output Mode Verification Test

Characteristics

Autovernier

In Normal mode, all parameters can be automatically incremented or decremented with selectable resolution. Pressing the **AUTO** key enables the autovernier, which can then be started by pressing the required vernier key. The autovernier is stopped by an external trigger input or by pressing the **AUTO** key again.

Output modes

- Complement** Inverts the output signal.
- Disable** Disconnects the output (default on switching on).
- Limit** Implements the present output levels as output limits.

Test Setup

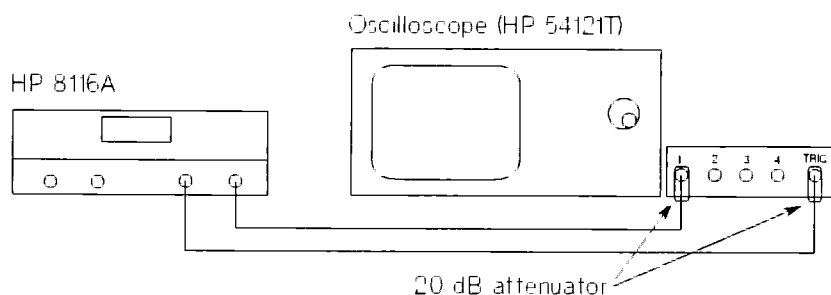

Figure 8-17. Autovernier & Output Mode Verification Test

- Equipment**
- Oscilloscope (HP 54121T)
 - Counter (HP 5335A)
 - Cable Assembly BNC (2 ×)
 - Attenuator 20 dB, 2 W (2 ×)

Procedure

1. Connect the equipment as shown in the setup figure
2. Set up the HP 8116A as follows:

Trigger Mode	NORM
Trigger Slope	Off
Control Mode	Off
Waveform	Square
Complement Output	Off
FRQ	1 kHz
HIL	1 V
LOL	0 V
DTY	10%
Limit Mode	Off

3. Set the oscilloscope timebase to 0.2 ms/division
4. Select autovernier mode on the HP 8116A by pressing the **AUTO** key.

Note



The autovernier acts on the currently selected parameter therefore make sure that DTY is the current parameter.

5. Press the upper part of the right hand vernier key and verify that the duty cycle of the HP 8116A output is incremented up to 90% in steps of 1%.
6. Press the lower part of the middle vernier key and verify that the duty cycle is decremented to 10% in steps of 10%.
7. Deselect autovernier mode by pressing the **AUTO** key.
8. Verify that the output signal is inverted by pressing the **COMPL** key.
9. Deselect the **COMPL** key.
10. Verify that the **DISABLE** key disables the output signal.
11. Re-enable the output signal.
12. Set up the HP 8116A as follows:

Trigger Mode	E.BUR
Trigger Slope	Off
Control Mode	Off
Waveform	Pulse
Complement Output	Off
FRQ	100 Hz
WID	5 μ s
BUR	123
HIL	1 V
LOL	-1 V
Limit Mode	On

13. Disconnect the oscilloscope and connect the counter in its place.

14. Set the counter to **TOT A** and enable its **GATE**.
15. Press the **MAN** key on the HP 8116A to simulate an external trigger and verify that the counter counts 123 pulses.
16. If you have Opt. 001 fitted, press the **1 CYCLE** key and confirm that the counter reading increments to 124.
17. Select the **HIL** parameter and verify that the vernier keys do not increase the HIL beyond the +1.0 V set previously.
18. Select the **LOL** parameter and verify that the vernier keys do not decrease the LOL below the -1.0 V set previously.

HP-IB Verification Test

Test Setup

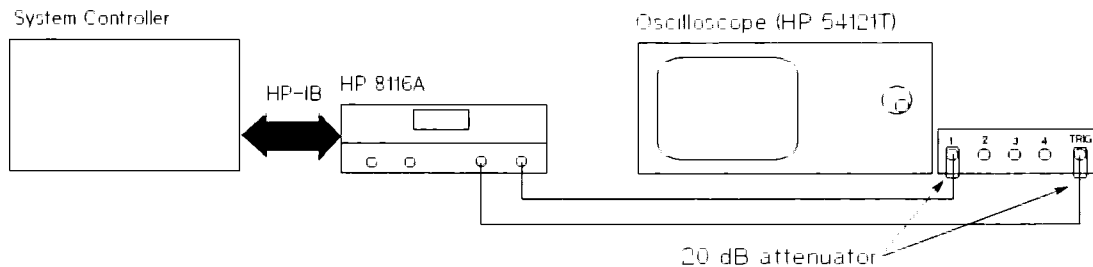

Figure 8-18. HP-IB Verification Test

- Equipment**
- Controller (HP Series 200/300)
 - Oscilloscope (HP 54121T)
 - Cable Assembly BNC (2 ×)
 - HP-IB cable

Procedure

Note



All program statements assume that the HP 8116A is at HP-IB address 16 and that BASIC 5.0/5.1 is being used.

1. Connect the equipment as shown in the setup figure
2. Use the following program statements to read the HP 8116A Standard Parameter Set:

DIM A\$[161]	<i>Allocate controller memory to receive HP 8116A status string</i>
REMOTE 716	<i>Set HP 8116A to remote mode</i>
CLEAR 716	<i>Clear HP 8116A status and select standard parameter set</i>
OUTPUT 716;"CST"	<i>Request current settings from HP 8116A</i>
ENTER 716;A\$	<i>Read the HP 8116A settings</i>
PRINT A\$	<i>Display the HP 8116A settings</i>

3. Verify that the result is:

```
M1,CTO,T1,W1,H0,A0,LO,CO,D1,BUR 0001 #,RPT 100 MS,  
STA 1.00 KHZ,STP 100 KHZ,SWT 50.0 MS,MRK 1.00 KHZ,  
FRQ 1.00 KHZ,DTY 50 %,WID 500 US,HIL 0.50 V,LOL -0.50 V
```

Note



If you do not have Opt 001 fitted, the Opt 001 parameters will not be part of the status string.

4. Use the following program statements to change some instrument settings and then re-read the current settings:

DIM B\$[161]	<i>Allocate controller memory to receive second status string</i>
OUTPUT 716;"FRQ 10 KHZ, DTY 10 %, W3,HIL 1.5 V, DO"	<i>Change settings</i>
OUTPUT 716;"CST"	<i>Request current settings from HP 8116A</i>
ENTER 716;B\$	<i>Read the HP 8116A settings</i>
PRINT B\$	<i>Display the HP 8116A settings</i>

5. Verify that the settings are the same as before, except for the following.

```
FRQ 10.0 KHZ  
DTY 10 %  
HIL 1.50 V  
W3  
DO
```

6. Using the oscilloscope confirm that the HP 8116A output has the following form:

Waveform	Square
FRQ	10 kHz
DTY	10%
HIL	1.5 V
LOL	-0.5 V

PERFORMANCE TEST RECORD: Hewlett-Packard 8116A 50 MHz Pulse/Function Generator

Serial No: _____ Report No: _____ Date: _____

Test Facility :

Test Conditions :

Installed Options : _____

Ambient Temperature : _____ °C

Relative Humidity : _____ %

Line Frequency : _____ Hz

Special Notes :

PERFORMANCE TEST RECORD: Hewlett-Packard 8116A 50 MHz Pulse/Function Generator

Serial No: _____ Report No: _____ Date: _____

Frequency

Frequency	Minimum	MEASURED	Maximum	Uncertainty
50.0 MHz	47.5 MHz		52.5 MHz	
10.0 MHz	9.5 MHz		10.5 MHz	
10.0 kHz	9.7 kHz		10.3 kHz	
1.00 kHz	0.97 kHz		1.03 kHz	
1.00 Hz	0.967 s		1.033 s	
100 mHz	9.66 s		10.33 s	

Duty Cycle

Frequency	Duty cycle	Minimum	MEASURED	Maximum	Uncertainty
1 Hz	10%	9.5%		10.5%	
	50%	49.5%		50.5%	
	90%	89.5%		90.5%	
1 kHz	10%	9.5%		10.5%	
	50%	49.5%		50.5%	
	90%	89.5%		90.5%	
9.99 MHz	20%	17.0%		23.0%	
	50%	47.0%		53.0%	
	80%	77.0%		83.0%	

Pulse Width

Width	Minimum	MEASURED	Maximum	Uncertainty
100 ns	93 ns		107 ns	
1 μ s	948 ns		1052 ns	
100 μ s	95 μ s		105 μ s	
1 ms	950 μ s		1050 μ s	
500 ms	475 ms		525 ms	
8 ns			10 ns	

Serial No: _____ Report No: _____ Date: _____

Amplitude & Offset

Amplitude

Amplitude	Waveform	Minimum	MEASURED	Maximum	Uncertainty
8.00 V	Sine	2.69 V		2.97 V	
	Triangle	2.19 V		2.43 V	
	Square	3.8 V		4.2 V	
3.00 V	Sine	1.008 V		1.114 V	
	Triangle	0.823 V		0.909 V	
	Square	1.425 V		1.575 V	
1.00 V	Sine	0.336 V		0.372 V	
	Triangle	0.275 V		0.303 V	
	Square	0.475 V		0.525 V	
100 mV	Sine	33.6 mV		37.1 mV	
	Triangle	27.4 mV		30.3 mV	
	Square	47.5 mV		52.5 mV	

Offset

Amplitude	Offset	Minimum	MEASURED	Maximum	Uncertainty
100 mV	7.50 V	7.421 V		7.587 V	
	5.00 V	4.934 V		5.066 V	
	3.00 V	2.944 V		3.056 V	
	1.00 V	0.954 V		1.046 V	
	100 mV	58 mV		142 mV	
10 mV	795 mV	783 mV		807 mV	
	500 mV	491 mV		509 mV	
	100 mV	95 mV		105 mV	

PERFORMANCE TEST RECORD: Hewlett-Packard 8116A 50 MHz Pulse/Function Generator

Serial No: _____ Report No: _____ Date: _____

Sine Waveform

THD at 1 kHz Measured: _____ ± _____
 (Specified $\leq 1\%$)

Worst Harmonic at 50 MHz Measured: _____ ± _____
 (Specified ≤ -23 dB relative to fundamental)

Pulse/Squarewave Waveform

Characteristic	Specification	MEASURED	Uncertainty
Risetime (leading edge)	≤ 7 ns		
Falltime (trailing edge)	≤ 7 ns		
Preshoot	$\leq \pm 5\%$ of amplitude		
Overshoot/Ringing	$\leq \pm 5\%$ of amplitude		

DC output

Offset	Minimum	MEASURED	Maximum	Uncertainty
+7.95 V	+7.890 V		8.010 V	
+5.00 V	+4.955 V		5.045 V	
+2.00 V	+1.970 V		2.030 V	
0.00 V	-0.020 V		+0.020 V	
-2.00 V	-2.030 V		-1.970 V	
-5.00 V	-5.045 V		-4.955 V	
-7.95 V	-8.010 V		-7.890 V	

Serial No: _____ Report No: _____ Date: _____

**Trigger, Gate and
External Width
modes**

Trigger Positive trigger initiates one complete output cycle: **YES/NO**

Gate Positive gate enables output cycles, last cycle completed: **YES/NO**

External Width Positive pulse enables output pulse of same length: **YES/NO**

**Burst modes
(Opt 001)** Number of output cycles = set burst number: **YES/NO**

**Frequency
Modulation** Measured Jitter:

**Amplitude
Modulation**

**Worst Sideband
Harmonic** Measured:
(Typically ≤ -42 dB relative to sideband)

Serial No: _____ Report No: _____ Date: _____

Pulse Width Modulation

Width Range	Minimum and Maximum achieved
10 ns to 100 ns	YES/NO
100 ns to 1.00 μ s	YES/NO
10 μ s to 100 μ s	YES/NO

Sweep modes (Opt 001)

Start frequency = 10 kHz:	YES/NO
IP displayed during sweep:	YES/NO
X-OUTPUT increases 0 V to 4.5 V during sweep:	YES/NO
Sweep duration = 6 s:	YES/NO
Stop frequency = 10 MHz:	YES/NO
MARKER OUTPUT functioning:	YES/NO
Internal sweep functioning:	YES/NO

Autovernier and Output modes

Autovernier functioning:	YES/NO
Complement output mode functioning:	YES/NO
MAN key functioning:	YES/NO
1 CYCLE key functioning (Opt 001 only):	YES/NO
Limited output mode functioning:	YES/NO

HP-IB programming

HP-IB functioning:	YES/NO
--------------------	--------

Adjustment Procedures

Safety Considerations

Warning



Dangerous voltages, capable of causing serious personal injury, are present in this instrument. Use extreme caution when handling, testing and adjusting.

The adjustments described in this chapter are performed with the instrument switched on and its protective covers removed. Therefore, the adjustments *must* only be carried out by a skilled person, who is aware of the hazards involved, and in the presence of another person who is capable of rendering first aid and resuscitation.

Capacitors inside the instrument may still be charged after the instrument has been disconnected from its external power supply.

Any disconnection of the protective ground connection, inside or outside the instrument, is prohibited, as this is likely to make the instrument dangerous.

Introduction

This chapter describes the adjustment procedures which return the HP 8116A to peak operating condition after repairs are completed. The procedures cover:

- Power Supply & Preliminary Adjustments
- Overshoot & Transition Time Adjustment
- Voltage Controlled Oscillator Adjustment
- Width Adjustment
- Shaper Adjustment
- Offset Adjustment
- Amplitude Modulator Adjustment

Note



Always allow the HP 8116A to warm up for at least 1 hour before starting any adjustment procedures.

The Power Supply and Preliminary adjustment procedure must *always* be carried out after any repairs. If any re-adjustment is required during this procedure then all the remaining procedures must be carried out. If no re-adjustment is required during the

Power Supply and Preliminary adjustment procedure then only those procedures which the repair could affect need to be carried out.

Always carry out an adjustment procedure completely and in the order in which it is presented.

Some of the adjustment procedures may require components to be changed. These components are summarised in Table 9-1.

Warning



Do not change a component while power is connected to the instrument.

Figure 9-8 and Figure 9-9 at the end of the chapter show the locations of all the adjustment points in the instrument.

Table 9-1. Adjustment Procedures - Changeable Components

Procedure	Reference	Range	Description
Overshoot/ Transition	A1C530	Jumper or 1 pF	Jumper increases overshoot
	A1 C525	1.5 pF – 15 pF	Decreasing the value increases transition time
VCO	A1R220/223	1.5 kΩ – 4.02 kΩ	Increasing the value increases amplitude flatness
Width	A1R309	1 Ω – 100 Ω	Increasing the value decreases minimum width
	A1R157	4.5 kΩ – 5.56 kΩ	Increasing the value decreases width in PWM
Shaper	A1R439	7.5 kΩ – open	Increasing the value increases offset in normal output and decreases offset in complement output modes
	A1R428	10 kΩ – open	Decreases 2nd harmonic at 1 V amplitude (Increasing the value decreases negative offset)

Test Equipment

Refer to Table 1-1 and Table 1-2 for the recommended test equipment

Power Supply & Preliminary Adjustments

Note



If any adjustments are required during this procedure, *all* adjustment procedures must be performed subsequently.

If the HP 8116A is very badly out of adjustment, turn A1R413 fully clockwise and all other adjustment potentiometers to their mid position. Then carry out *all* the adjustment procedures.

Equipment

- Digital Voltmeter (HP 3456A)
- Oscilloscope (HP 54121T)
- Attenuator 20 dB (3 ×)

Procedure

Power Supplies

1. Connect the DVM low terminal to the ground testpoint on board A1.
2. Test the supply voltages and, if necessary, make adjustments to achieve the levels given here:

Testpoint	Adjust	Result
A1+15 V	A1R24	+15.000 V ±15 mV
A1-5.2 V	A1R12	-5.250 V ±10 mV
A1+5.0 V	-	+5.050 V ±50 mV
A3+5.0 V	-	+5.150 V ±50 mV
A1+24 V	A1R18	+24.000 V ±50 mV
A1-24 V	A1R19	-24.000 V ±50 mV
A1-15 V	A1R25	-15.000 V ±15 mV

3. Disconnect the DVM.

Square High Amplitude & Offset

4. Set up the HP 8116A as follows:

Trigger Mode	NORM
Control Mode	Off
Waveform	Square
Complement Output	Off
Disable Output	On\
FRQ	100 kHz
DTY	50%
AMP	16 V
OFS	0 V

5. Connect the HP 8116A's main output to the oscilloscope via 40 dB attenuation, then set the oscilloscope channel's attenuation-factor to 100 and its offset to 0 V.
6. Connect the HP 8116A's trigger output to the oscilloscope's trigger input via 20 dB attenuation.
7. Enable the HP 8116A's output.
8. Adjust the oscilloscope for 2 V/div vertically and 2 μ s/div.
9. Adjust A1R410 (amplitude) and A1R425 (offset) to achieve an output amplitude of 16 V (8 divisions) symmetrical about 0 V.

Triangle High Amplitude & Offset

10. Set the HP 8116A waveform to triangle.
11. Adjust A1R227 (amplitude) and A1R407 (balance) to achieve an output amplitude of 16 V (8 divisions) symmetrical about 0 V.

Sine High Amplitude & Offset

12. Set the HP 8116A waveform to sine.
13. Adjust A1R418 (amplitude) and A1R402 (balance) to achieve an output amplitude of 16 V (8 divisions) symmetrical about 0 V.
14. Adjust A1R409 to give the best sinewave signal.

Square Low Amplitude & Offset

15. Set up the HP 8116A as follows:

Waveform	Square
AMP	1 V
OFS	0 V

16. Re-connect the HP 8116A's main output to the oscilloscope using only 20 dB attenuation and set the channel attenuation-factor to 20.
17. Adjust the oscilloscope to 200 mV/div. Using Delta V mode set Marker 1 to -500 mV and Marker 2 to +500 mV.
18. Turn A1R450 fully anti-clockwise.

19. Adjust A1R450 and A1R416 to achieve an output amplitude of 1 V (5 divisions) symmetrical about 0 V.

Sine Low Amplitude

20. Set the HP 8116A waveform to sine.
21. Turn A1R445 fully clockwise and then adjust it to achieve an output amplitude of 1 V (5 divisions).

Low Frequency Pulse Performance

22. Set up the HP 8116A as follows:

Waveform	Square
FRQ	1 kHz

23. Set the oscilloscope timebase to 200 μ s/div.
24. Adjust A1R515 to achieve the best squarewave signal.

Overshoot & Transition Time Adjustment

- Equipment**
- Oscilloscope (HP 54121T)
 - Attenuator 20 dB (3 ×)

Procedure

1. Set up the HP 8116A as follows:

Trigger Mode	NORM
Control Mode	Off
Waveform	Triangle
Complement Output	Off
Disable Output	On
FRQ	10 MHz
DTY	50%
AMP	1.6 V
OFS	0 V
2. Connect the HP 8116A's main output to the oscilloscope via 20 dB attenuation, then set the channel attenuation-factor to 20 and the offset to 0 V.
3. Connect the HP 8116A's trigger output to the oscilloscope's trigger input via 20 dB attenuation.
4. Set the oscilloscope to 200 mV/div and 20 ns/div.
5. Enable the HP 8116A's output.
6. Adjust A1R535 to give a linear, triangular waveform.
7. Add a second 20 dB attenuator to the oscilloscope input which you are using and set the channel attenuation-factor to 100.
8. Set up the HP 8116A as follows:

Waveform	Square
AMP	16 V
9. Set the oscilloscope to 5 V/div.
10. Adjust A1C529, in normal and complement output modes, to achieve overshoot < 4%.
11. Set the HP 8116A output amplitude to 1 V.
12. Remove the second 20 dB attenuator from the oscilloscope input and set the channel attenuation-factor to 10.
13. Set the oscilloscope to 200 mV/div.
14. Adjust A1R535, in normal and complement output modes, to achieve overshoot < 4%.
15. Add the second 20 dB attenuator back to the oscilloscope input and set the channel attenuation-factor to 100.

16. Set the HP 8116A amplitude to 16 V.
17. Re-adjust A1R535 to achieve overshoot < 4%.
18. Set the HP 8116A output to 1 V.
19. Remove the second 20 dB attenuator from the oscilloscope input and set the channel attenuation-factor to 10.
20. Check that the transition times are < 6.6 ns in both normal and complement output modes. Transition time is measured between 10% and 90% of amplitude.
21. Set the HP 8116A output amplitude to 999 mV
22. Check that the transition times are < 6.6 ns in both normal and complement output modes.
23. Add a 6 dB attenuator to the oscilloscope input and set the channel attenuation-factor to 20.
24. Set up the HP 8116A as follows:

AMP	1 V
OFS	7.5 V
25. Set the oscilloscope channel-offset to 7.5 V and select averaged display mode with 8 averages.
26. Check that the transition times are < 6.6 ns in both normal and complement output modes.

Note



Transition times can be reduced by increasing the overshoot. If it is impossible to achieve the specifications for both these parameters, change the values of A1C525 and A1C530. Refer to Table 9-1.

Voltage Controlled Oscillator Adjustment

- Equipment**
- Counter (HP5335A)
 - Oscilloscope (HP 54121T)
 - Spectrum Analyzer (HP 8568B)

Procedure

Frequency & Duty Cycle (100 Hz - 999 kHz)

1. Set up the HP 8116A as follows:

Trigger Mode	NORM
Control Mode	Off
Waveform	Triangle
Complement Output	Off
Disable Output	Off
DTY	50%
AMP	999 mV
OFS	0 V

2. Set the counter to **TIME A→B, COMA f , B λ , Trig level 0 V.**
3. Set the counter input impedance to 50 Ω . If this is not possible, fit a 50 Ω feedthrough terminator to the counter input.
4. Connect the HP 8116A's trigger output to the counter.
5. Set the HP 8116A frequency to 1 kHz.
6. Adjust A2R22 until the measured time is 500 $\mu\text{s} \pm 0.5 \mu\text{s}$.
7. Set the HP 8116A frequency to 9.99 kHz.
8. Adjust A2R27 until the measured time is 50.05 $\mu\text{s} \pm 0.05 \mu\text{s}$.
9. Repeat the previous 4 steps until both specifications are achieved.
10. Set the counter trigger-slopes to **A λ , B f .**
11. Set the HP 8116A frequency to 1 kHz.
12. Adjust A2R25 until the measured time is 500 $\mu\text{s} \pm 0.5 \mu\text{s}$.
13. Set the HP 8116A frequency to 9.99 kHz.
14. Adjust A2R27 until the measured time is 50.05 $\mu\text{s} \pm 0.05 \mu\text{s}$.
15. Repeat the previous 4 steps until both specifications are achieved.

Frequency (1 MHz - 9.99 MHz)

16. Set the counter to measure frequency.
17. Set the counter trigger-slopes to **A f , B λ .**

18. Set the HP 8116A frequency to 9.99 MHz.
19. Adjust A1C204 until the measured frequency is 9.99 MHz \pm 0.5 MHz.
20. Set the HP 8116A frequency to 1.00 MHz.
21. Adjust A1C204 until the measured frequency is 1.00 MHz \pm 0.05 MHz.
22. Repeat the previous 4 steps until both specifications are achieved.

Flatness

23. Set the HP 8116A frequency to 2.99 MHz.
24. Connect the HP 8116A's main output to the oscilloscope via a 6 dB attenuator and set the channel attenuation-factor to 2.
25. Connect the HP 8116A's trigger output to the oscilloscope's trigger input via a 20 dB attenuator.
26. Set the oscilloscope to 160 mV/div and 100 ns/div.
27. Record the amplitude of the output signal.
28. Set the HP 8116A frequency to 9.99 MHz.
29. Check that the output amplitude has decreased by between 2% and 4% of the amplitude at 2.99 MHz. If not, you must change the values of both A1R220 and A1R223 (both must have the same value). Refer to Table 9-1.

High Frequency and Flatness (10 MHz - 50 MHz)

30. Set the HP 8116A frequency to 10 MHz.
31. Connect the HP 8116A's trigger output back to the counter.
32. Adjust A2R17 until the measured frequency is 10.00 MHz \pm 0.03 MHz.
33. Re-connect the HP 8116A's trigger output to the oscilloscope's trigger input.
34. Set the HP 8116A frequency to 2 MHz
35. Use the oscilloscope's ΔV markers to mark the current amplitude levels, or record them by hand.
36. Set the HP 8116A frequency to 50 MHz.
37. Set the oscilloscope timebase to 20 ns/div.
38. Adjust A1R221 and A1R224 to achieve a symmetrical output signal, as shown in Figure 9-1, and a measured frequency of 50.0 MHz \pm 1.0 MHz. (You will have to connect the HP 8116A's trigger output to the counter to measure the frequency).

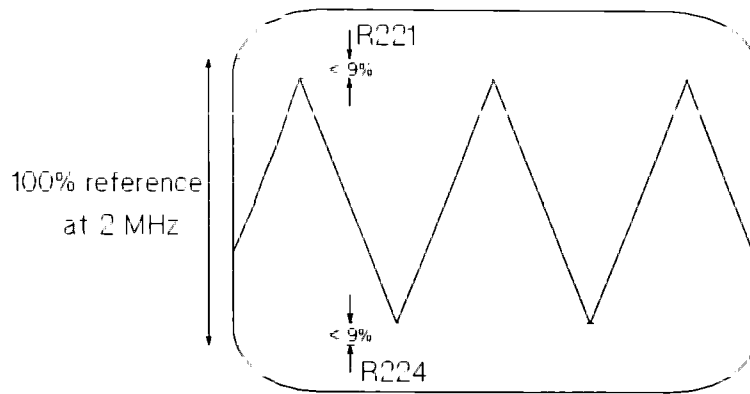

Figure 9-1. HF symmetry adjustment

39. Connect the HP 8116A's main output to the spectrum analyzer.
40. Adjust the analyzer to show the fundamental, at 0 dB, and at least the first two harmonics.
41. Re-adjust A1R221 and A1R224 for minimum 2nd harmonic distortion.
42. Switch on complement-output mode on the HP 8116A and re-adjust A1R221 for minimum 2nd harmonic distortion.
43. Switch off complement-output mode on the HP 8116A.
44. Repeat the previous three steps until you achieve the best compromise between normal and complement outputs.
45. Set the HP 8116A frequency to 42 MHz
46. Check that the frequency measured by the counter is < 43.5 MHz.
47. Connect the HP 8116A's main output to the oscilloscope, and the HP 8116A's trigger output to the oscilloscope's trigger input.
48. Check that the amplitude remains within 20% of its value at 2 MHz throughout the frequency range 40 MHz to 50 MHz.
49. Set up the HP 8116A as follows:

Waveform	Square
FRQ	50 MHz
50. Adjust A1R130 to achieve approximately 50% duty cycle.(Toggle complement output on and off and obtain the best compromise).

Low Frequency (1 mHz – 99.9 Hz)

51. Set up the HP 8116A as follows:

Waveform	Square
FRQ	99.9 Hz
DTY	50%
AMP	1 V
OFS	0 V

52. Connect the HP 8116A's trigger output to the counter.

53. Adjust A2R18 until the measured frequency is 99.9 Hz \pm 0.1 Hz.

54. Set the HP 8116A frequency to 9.99 Hz.

55. Adjust A2R2 until the measured frequency is 9.99 Hz \pm 0.025 Hz

56. Switch the counter to measure duty cycle.

Note



If the counter you are using does not measure duty cycle directly, measure the on-time and off-time of the output signal and calculate the duty cycle.

57. Adjust A2R4 until the duty cycle is 50% \pm 0.2.

58. Repeat the previous 2 adjustments until the best compromise is obtained.

Width Adjustment

- Equipment**
- Counter (HP5335A)
 - Oscilloscope (HP 54121T)

Procedure

1. Set up the HP 8116A as follows:

Trigger Mode	NORM
Control Mode	Off
Waveform	Pulse
Complement Output	Off
Disable Output	Off
FRQ	900 Hz
AMP	1 V
OFS	0 V

2. Set the counter to **TIME A→B, COMA f, B λ, Trig level 0 V**.

3. Set the counter input impedance to 50 Ω. If this is not possible, fit a 50 Ω feedthrough terminator to the counter input.

4. Connect the HP 8116A's main output to the counter.

5. Set the HP 8116A width parameter to 100 μs.

6. Adjust A2R32 until the measured time is $102 \mu\text{s} \pm 1 \mu\text{s}$.
7. Set the HP 8116A width parameter to $999 \mu\text{s}$.
8. Adjust A1R304 until the measured time is $1020 \mu\text{s} \pm 10 \mu\text{s}$.
9. Repeat the previous 4 steps until both specifications are achieved.
10. Set the HP 8116A width parameter to $400 \mu\text{s}$.
11. Check that the measured time $> 386 \mu\text{s}$. If not, start this procedure again.
12. Set up the HP 8116A as follows:

WID	99.9 ns
FRQ	100 kHz
13. Adjust A2R31 until the measured time is $100 \text{ ns} \pm 1 \text{ ns}$.
14. Set up the HP 8116A as follows:

WID	8 ns
FRQ	10 MHz
15. Connect the HP 8116A's main output to the oscilloscope via a 20 dB attenuator, then set the channel attenuation-factor to 10.
16. Connect the HP 8116A's trigger output to the oscilloscope's trigger input using a 20 dB attenuator.
17. Adjust the oscilloscope to display a single output pulse.
18. Measure the pulse width (at 50% of amplitude) and check that $6.7 \text{ ns} < \text{width} < 9.5 \text{ ns}$. If not, change the value of R309 (Refer to Table 9-1).
19. Set up the HP 8116A as follows:

Trigger Mode	NORM
Control Mode	PWM
Waveform	Pulse
Complement Output	Off
Disable Output	Off
FRQ	1 kHz
WID	$550 \mu\text{s}$
AMP	1 V
OFS	0 V
20. Connect the HP 8116A's main output to the counter.
21. Check that the measured width is $550 \mu\text{s} \pm 30 \mu\text{s}$. If not, you must change the value of A1R157 (Refer to Table 9-1).

Shaper Adjustments

Equipment

- Digital Voltmeter (HP 3456A)
- Spectrum Analyzer (HP 8568B)
- Low pass filter (Refer to Figure 9-2)
(Only required if DVM does not have built-in 5 Hz low-pass input filter.)

Procedure

1. If you have not already done so, turn A1R413 fully clockwise.

Square amplitude

2. Set up the HP 8116A as follows:

Trigger Mode	NORM
Control Mode	Off
Waveform	Square
Complement Output	Off
Disable Output	Off
FRQ	1.00 kHz
AMP	9.99 V
OFS	0 V

3. Set up the DVM to read AC voltages up to 10 V.
4. Connect the HP 8116A's main output via a 50 Ω feedthrough terminator to the DVM.
5. Adjust A1R410 until the measured voltage is 5.055 V \pm 25 mV.
6. Set the HP 8116A amplitude to 16 V.
7. Check that the measured voltage is > 8.080 V.
8. Set the HP 8116A amplitude to 1 V.
9. Adjust A1R450 until the measured voltage is 0.504 V \pm 4 mV.

Square Normal/Complement Output Balance

10. Set up the HP 8116A as follows:

AMP	16 V
OFS	0 V

11. Connect the HP 8116A's main output to the DVM, enable the DVM's built-in filter and set the DVM to read DC voltages. If the DVM does not have a built-in filter, use an external low pass filter, as shown in Figure 9-2.

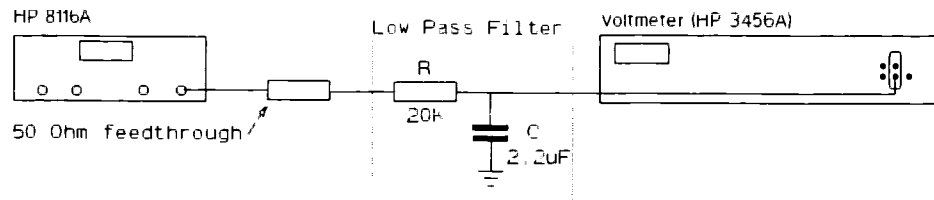

Figure 9-2. Low Pass Filter

12. Switch complement output mode on and off, and adjust A1R403 to obtain the minimum amplitude difference between the 2 modes (< 10 mV).

Triangle Amplitude

13. Set up the HP 8116A as follows:

Waveform	Triangle
Complement Output	Off
Disable Output	Off
AMP	9.99 V
OFS	0 V

14. Set up the DVM to read AC voltages up to 10 V.
15. Connect the HP 8116A's main output via a 50 Ω feedthrough terminator to the DVM.
16. Adjust A1R227 until the measured voltage is 2.918 V ± 15 mV.
17. Set the HP 8116A amplitude to 16 V.
18. Check that the measured voltage is > 4.660 V.

2nd Harmonic Distortion

19. Set up the HP 8116A as follows:

Waveform	Sine
Complement Output	Off
Disable Output	Off
FRQ	3 kHz

20. Connect the HP 8116A's main output to the spectrum analyzer.
21. Set up the analyzer to show the fundamental, at 0 dB, and the first two harmonics. (Refer to Figure 9-3).

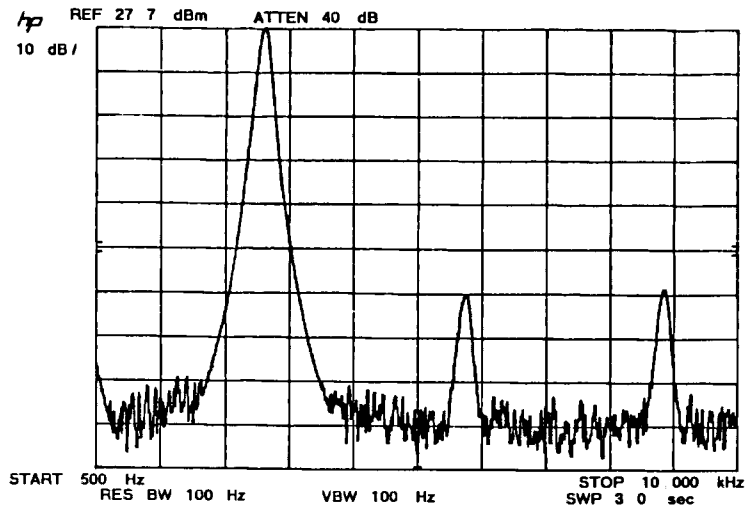

Figure 9-3. Typical Spectrum During 2nd Harmonic Adjustment

22. Adjust A1R409 until the 3rd harmonic is at minimum amplitude.
23. Adjust A1R407 until the 2nd harmonic is at minimum amplitude.
24. Switch the HP 8116A complement-output mode on and off, and adjust A1R407 to obtain the minimum difference between the 2nd harmonic in each mode.
25. If the 2nd harmonic is not < -48 dB in both normal- and complement-output modes, adjust A1R417 until this is achieved.

Sine Normal/Complement Balance

26. Set up the HP 8116A as follows:

Trigger Mode	NORM
Control Mode	Off
Waveform	Sine
Complement Output	Off
Disable Output	Off
FRQ	1.00 kHz
AMP	16 V
OFS	0 V

27. Set up the DVM to read DC voltages up to 10 V.
28. Connect the HP 8116A's main output via a 50Ω feedthrough terminator to the DVM, and enable the DVM's built-in filter. If the DVM does not have a built in filter, use a low-pass filter as shown in Figure 9-2.
29. Switch the HP 8116A complement-output mode on and off, and adjust A1R402 until the difference in output level is < 10 mV between normal- and complement-output modes. If this cannot be achieved, change the value of A1R439 (Refer to Table 9-1), and re-start this procedure from *Square Normal/Complement Output Balance*.

Sine Amplitude & THD

30. Set up the HP 8116A as follows:

AMP	9.99 V
OFS	0 V

31. Set up the DVM to read AC voltages up to 10 V.

32. Connect the HP 8116A's main output via a 50 Ω feedthrough terminator to the DVM, and disable the DVM's built-in filter (or remove the low-pass filter, if connected).

33. Adjust A1R418 until the measured voltage is 3.530 V \pm 10 mV.

34. Set the HP 8116A amplitude parameter to 1 V.

35. Adjust A1R445 until the measured voltage is 0.354 V \pm 1 mV.

36. Set up the HP 8116A as follows:

FRQ	3.00 kHz
AMP	9.99 V
OFS	0 V

37. Connect the HP 8116A's main output to the spectrum analyzer.

38. Set up the analyzer to show the fundamental at 0 dB, and the first 2 harmonics.

39. Adjust A1R409 until the 3rd harmonic's amplitude is a minimum (< -50 dB).

40. Repeat the *Sine Amplitude & THD* procedure until all values are within the given limits.

Triangle Normal/Complement Output Balance

41. Set up the HP 8116A as follows:

Waveform	Triangle
Complement Output	Off
Disable Output	Off
FRQ	1 kHz
AMP	16 V
OFS	0 V

42. Set up the DVM to read DC voltages up to 10 V.

43. Connect the HP 8116A's main output via a 50 Ω feedthrough terminator to the DVM, and enable the DVM's built-in filter. If the DVM does not have a built-in filter, use a low-pass filter as shown in Figure 9-2.

44. Switch the HP 8116A complement-output mode on and off, and adjust A1R401 until the difference in output level is < 10 mV between normal- and complement-output modes. If this cannot be achieved, change the value of A1R439 (Refer to Table 9-1), and re-start this procedure from *Square Normal/Complement Output Balance*.

Sine Offset

45. Set the HP 8116A waveform to sine.
46. Adjust A1R425 until the measured voltage is $0.00\text{ V} \pm 10\text{ mV}$.
47. Set the HP 8116A amplitude to 1 V.
48. Adjust A1R416 until the measured voltage is $0.00\text{ V} \pm 5\text{ mV}$.

Square Low Amplitude

49. Set the HP 8116A waveform to square.
50. Set up the DVM to read AC voltages up to 10 V.
51. Switch off the DVM's built-in filter, or disconnect the low-pass filter.
52. Adjust A1R450 until the measured voltage is $0.506\text{ V} \pm 2\text{ mV}$.
53. Select sine waveform and repeat steps 34 and 35. If any adjustment is necessary, repeat all the rest of the steps up to this point, otherwise, continue from the next step.

THD Check

54. Set up the HP 8116A as follows:

Waveform	Sine
Complement Output	Off
Disable Output	Off
FRQ	3 kHz
AMP	1 V
OFS	0 V

55. Connect the HP 8116A's main output to the spectrum analyzer.
56. Set up the analyzer to show the fundamental at 0 dB, and the first two harmonics.
57. Switch the HP 8116A complement-output mode on and off, and adjust A1R407 until the 2nd harmonic is $< -45\text{ dB}$ in both normal- and complement-output modes. If not, change the value of R428. (Refer to Table 9-1).
58. Set up the HP 8116A as follows:

FRQ	50 MHz
AMP	100 mV
OFS	0 V
59. Set up the analyzer to show the fundamental at 0 dB, and the first two harmonics.
60. Switch the HP 8116A complement-output on and off, and check that the 2nd and 3rd harmonics are $< -26\text{ dB}$ in both cases.

Offset Adjustment

Equipment ■ Digital Voltmeter (HP 3456A)

- Procedure**
1. Set up the HP 8116A as follows:

Waveform	Sine
Complement Output	Off
Disable Output	Off
FRQ	1 kHz
DTY	50%
AMP	100 mV
OFS	7.95 V
 2. Set up the DVM to read DC voltages up to 10 V.
 3. Connect the HP 8116A's main output to the DVM and enable the DVM's built-in filter. If the DVM does not have a built-in filter, use a low pass filter, as shown in Figure 9-2.
 4. Adjust A2R43 until the measured voltage is $7.95\text{ V} \pm 30\text{ mV}$.
 5. Set the HP 8116A offset parameter to -7.95 V.
 6. Check that the measured voltage is $-7.95\text{ V} \pm 30\text{ mV}$.
 7. If any offset adjustment was required, repeat the "Overshoot" & "Transition Time Adjustment" procedure before continuing.

Amplitude Modulator Adjustment

Equipment ■ Function Generator (HP 3324A)
■ Oscilloscope (HP 54121T)
■ Spectrum Analyzer (HP 8568B)

Procedure

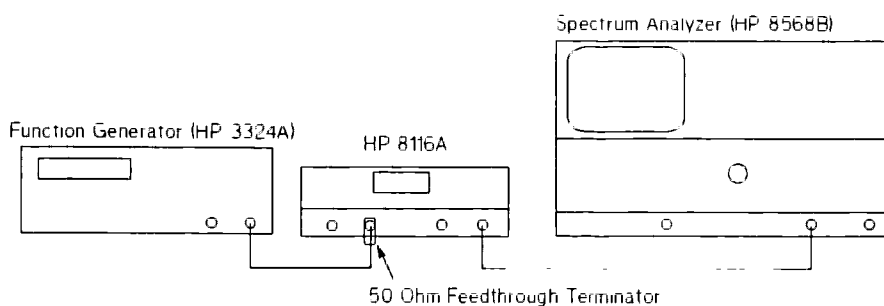

Figure 9-4. Amplitude Modulator Adjustment - Equipment Set-up.

1. Connect the function generator, HP 8116A and spectrum analyzer as shown in Figure 9-4.

2. Set up the HP 8116A as follows:

Trigger Mode	NORM
Control Mode	AM
Waveform	Sine
Complement Output	Off
Disable Output	Off
FRQ	15 kHz
DTY	50%
AMP	16 V
OFS	0 V

3. Set up the function generator as follows:

Waveform	Sine
Frequency	2 kHz
Amplitude	4.5 V
Offset	0 V

4. Adjust the spectrum-analyzer frequency range to display the 15 kHz carrier, the sidebands, the harmonics of the sidebands and the 2 kHz modulation signal as shown in Figure 9-5.

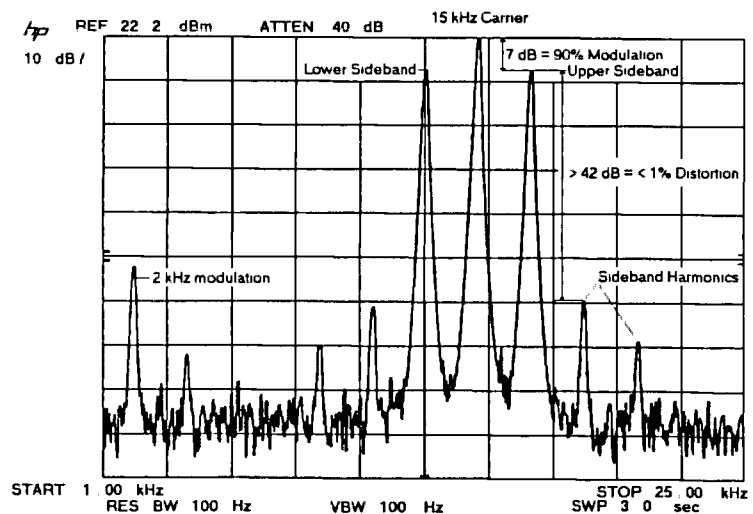

Figure 9-5. Amplitude Modulation Spectrum

5. Adjust the gain of the spectrum analyzer so that the carrier level is 0 dB.

6. Adjust the function generator's amplitude until the modulation sidebands are 7 dB down from the carrier. This corresponds to a modulation level of 90%.

7. Set A1R413 to its middle position.

8. Adjust A1R414 to minimize the level of the 2 kHz modulation signal and its 4 kHz harmonic.

9. Set the HP 8116A amplitude to 1 V.
10. Adjust the spectrum analyzer so that the carrier level is 0 dB.
11. Re-adjust A1R414 to minimize the level of the 2 kHz modulation signal and its 4 kHz harmonic.
12. Repeat the procedure up to this point in order to get the best compromise at both amplitude levels.
13. Verify that, at both amplitudes, all harmonics of the sidebands are at least 42 dB lower than the sidebands (49 dB lower than the carrier). Remember to adjust the spectrum analyzer each time you change the HP 8116A amplitude level, so that the carrier level is 0 dB.
14. Perform, or repeat, the following parts of the procedure in "Shaper Adjustments":
 - Sine Normal/Complement Output Balance
 - Steps 34 & 35 of Sine Amplitude & THD
 - Triangle Normal/Complement Output Balance
 - Square Low Amplitude (Set HP 8116A amplitude to 1.00 V)
15. Repeat step 13 of this procedure.
16. Disconnect the HP 8116A's main output from the analyzer and connect it to the oscilloscope via 40 dB attenuation.
17. Connect the sync output (or the main output) from the function generator to the oscilloscope's trigger input.
18. Set up the HP 8116A as follows:

FRQ	15 kHz
AMP	16 V
19. Set up the function generator as follows:

Amplitude	5 V
Offset	0 V
20. Adjust the function generator amplitude and offset until the HP 8116A has 100% modulation and minimum offset as shown in Figure 9-6. Figure 9-7 shows an incorrectly adjusted example.

PRO A1 BOARD

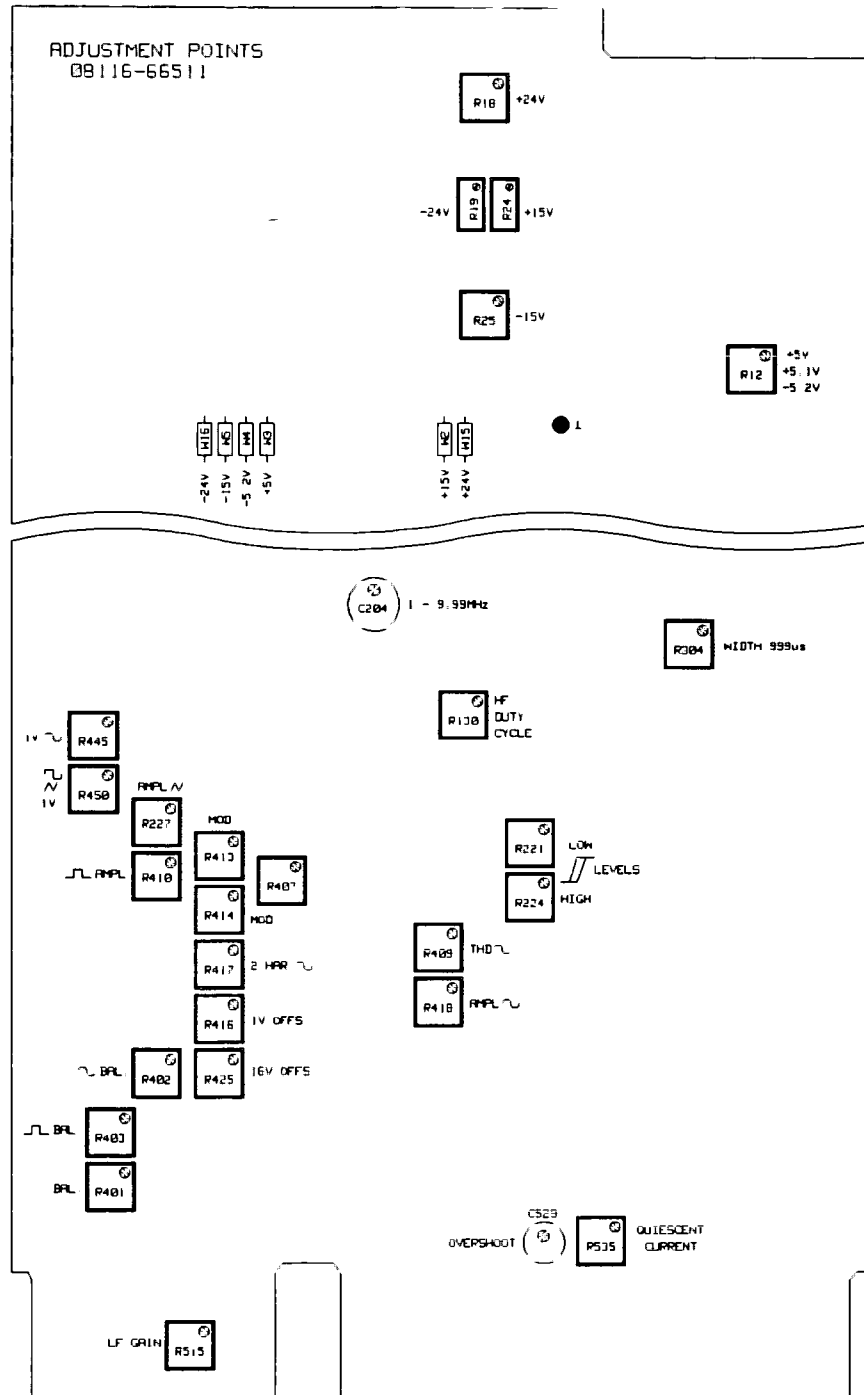

Figure 9-8. Adjustment Points on the Main Board A1

P O A2 BD AY

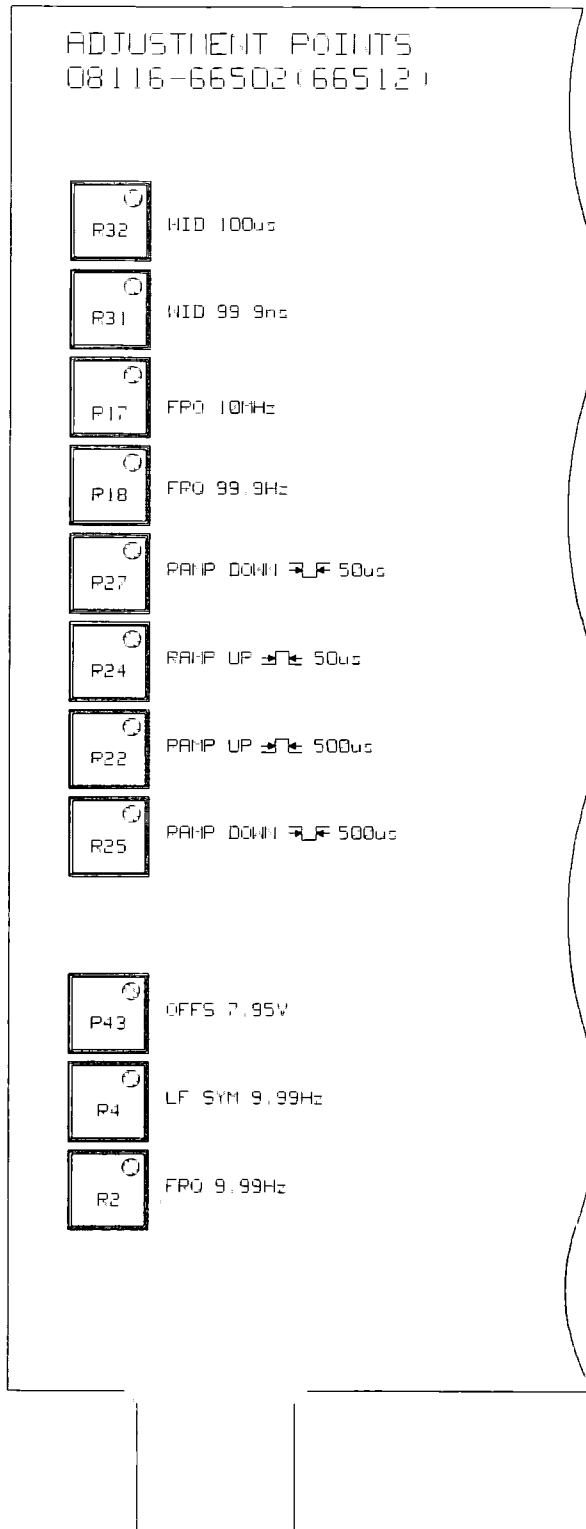

Figure 9-9. Adjustment Points on the Control Board A2