	<i>Reference</i> <i>SM TPU</i>	<i>Version</i> <i>1.0</i>	<i>Date</i> <i>6/9/2007</i>
	<i>ECD Energy Conversion Device</i>	<i>Number of pages</i> <i>55</i>	<i>Document state</i> <i>Approved</i>

TPU \equiv ECD
 INVENTED BY STEVEN MARK
 Energy Conversion Device
DISCLOSURE
 By
Otto and Roberto

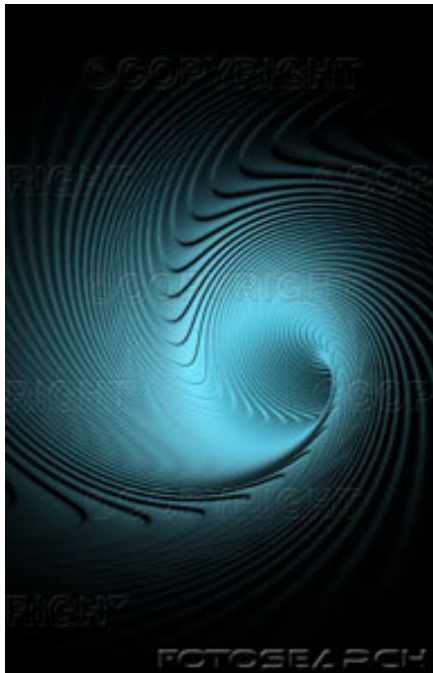

CLIENT : All interested.
PROJECT : ECD=TPU
DOCUMENT : Technical Relation.
Version : V. 1.0
DATE : 6/9/2007

Revision History						
REV.	DATE	Emission time	Author	Reviewed by	Approved by	Accepted by
G00-01.0	6/9/2007	First Emission	R. Notte, O. Sabljarić	R. Notte	O. Sabljarić	O. Sabljarić

Distribution Control		
Original Copy Controlled Copy Not controlled Copy	<input checked="" type="checkbox"/> <input type="checkbox"/> <input type="checkbox"/>	Sent to: Otto Sabljarić Printed: 6/9/2007

Acronyms' Table

SM	Steven Mark
TPU	Toroidal Power Unit
ECD	Energy Conversion Device
PS	Power Supply
CC	Control Coil
RE	Radiant Energy
Seed	The key to start the conversion process
ZERO	Common pulsing point
PHASE	Common output point

Index

- 1. INTRODUCTION 7
- 2. INITIAL OTTO’S TESTS..... 9
 - 2.1 50 TURNS-ON-TWO-FINGER EXPERIMENT9
 - 2.2 RING DIAMETER TESTS 11
- 3. BUILDING DETAILS 14
- 4. SWEET DTO CONSIDERATIONS 15
- 5. FIRST & FULL CONVERSION EVENT 17
 - 5.1 COLLECTOR - TESTS WITH VARIOUS METAL WIRES 19
 - 5.2 CONTROL COIL TRANSFORMER OPTIMIZATION..... 19
 - 5.2.1 Primary side tests 19
 - 5.2.2 Secondary side tests 25
 - 5.3 MOBIUS BASED ECD - A STUDY 28
- 6. INTRODUCTION 32
 - 6.1 TESTS WITH 2 CC WITH SERIES SECONDARY CONNECTION..... 32
 - 6.2 TESTS WITH 15” ECD 43
- 7. SEED’S SHORT STUDY 52
- 8. A SHORT FINAL CONSIDERATION 55

Fig. Index

- Fig. 1 - First 50 turns coil setup..... 9
- Fig. 2 - Improved 50 turn coil setup..... 9
- Fig. 3- Two coils setup..... 10
- Fig. 4 - Wing profile & Collector positioning options..... 12
- Fig. 5 Sweet DTO diagram as posted on 15
- Fig. 6 wire crossings 15
- Fig. 7 Correct crosses approach..... 16
- Fig. 8 Initial test setup 17
- Fig. 9 Collector output setup 19
- Fig. 10 Final 6” 2 Mobius coils twice cross-connected 28
- Fig. 11 RE peaks summing on leading pulse edge with 1 Freq. 32
- Fig. 12 ZERO POINT - RE peaks summing on leading pulse edge with 2 Freq. 33
- Fig. 13 An enlargement of fig. 11 33
- Fig. 14 Signal on MOSFET’s gates 34
- Fig. 15 PHASE point - RE peaks summing on leading pulse edge with 2 Freq. 34

Fig. 16 Time enlargement of Fig. 14	35
Fig. 17 Start of Conversion process.	36
Fig. 18 Time relation between ZERO and F3.....	37
Fig. 19 Time relation between ZERO and F3.....	37
Fig. 20 Detailed sinus forming.....	38
Fig. 21 3 created sinus.....	39
Fig. 22 Peak incorporation.....	39
Fig. 23 Light bulb 100W/230V.....	39
Fig. 24 Sine waves incorporating peaks	40
Fig. 25	40
Fig. 26 100W Light bulb brightness with 2 CC	41
Fig. 27 (05.31.2007 - 13:26) Advanced 2 coil freq adj	41
Fig. 28 (05.31.13:32) Various partial converted kicks	42
Fig. 29 (05.31.13:32) Details of a partial converted kick (on fig 27)	42
Fig. 30 16" ECD 3 CC and 1 Frequency	43
Fig. 31 (05.31.2007 - 13:36) the Kick eater.....	44
Fig. 32 (05.31.2007 - 13:38) Details of created sine wave (Seed on leading edge).....	44
Fig. 33 (06.01.2007 - 14:27) Signals on load leads - no conversion.....	45
Fig. 34 (06.01.2007 - 14:39) Signals on load leads - conversion @max.....	45
Fig. 35 (06.01.2007 - 15:47) More sine pieces fitting together.....	46
Fig. 36 (06.01.2007 - 15:42) Slow tuning in.....	46
Fig. 37 16" ECD - 1 CC and 1 Frequency.....	47
Fig. 38 (05.31.2007 - 15:52) 16" ECD - 2 CC and 2 Frequencies	47
Fig. 39 (05.31.2007 - 16:05) 16" ECD - 2 CC and 2 Frequencies - 1 Sine waves summing on top	48
Fig. 40 (05.31.2007 - 16:04) 16" ECD - 2 CC and 2 Frequencies - 2 Sine waves summing on top	48
Fig. 41 (06.02.2007 - 8:56) 16" ECD - 3 CC and 2 Frequencies - parallel connected -- almost full conversion.....	49
Fig. 42 (06.02.2007 - 15:53) 16" ECD - 3 CC and 2 Frequencies - parallel connected - almost full conversion.....	49
Fig. 43 The Seed (02.06.2007 - 16:09).....	52
Fig. 44 (05.31.2007 - 15:39) Magnesium Seed Signature	53

Foreword

This document is a complete and detailed Relation about a very special happening:

‘A COMPLETE ENERGY CONVERSION EVENT’

We¹ do intend that this document does circulate freely to all that may be interested in. This document may be freely duplicated & distributed without any possible restriction and without any claim by us.

WE DON'T WANT THIS DEVICE BE PATENTED.

Our purpose is just that to make it available to everyone without any limitation of any kind.

Please be anyway informed that ECD could be and certainly is a very, very dangerous device and if you make it we don't want to keep any kind of responsibility, so the advice is: make it only if you can apply proper safety measures.

ECD is born from a genuine intuition from *Otto Sabljarić* who did spent most of his last 2 years to develop & refine original ideas.

Roberto Notte main contribution was on the last period mainly to correctly discover, identify and document the actual **‘conversion process’**.

In this paper you will find few theoretical assessments: they, with the help of God, will come later. This paper that you are going to read is to be considered just as Preliminary, more data will follow as per requests also. A complete description of principles behind ECD may be found here².

**SM deserve a special and very big hand-shake and thanking.
Is only thanks to his original ideas materialized for us into
few footage of bad quality film, that has been possible to
REPLICATE his work.**

A last thing: it must be clear that SM is a very clever man, he spent most of his life to develop TPU. With the help of the new available technologies we succeeded in less than 1 year in obtaining a working replication.

¹ Otto Sabljarić and Roberto Notte.

² <http://magnetism.fateback.com/Overunity.htm>

1. INTRODUCTION

This DISCLOSURE document is divided into two main parts:

1. First part does follow a logical time-line in order to clear the way that finally led to a full conversion event. It does report mainly about the Otto's hard work in finding the right coils & Mobius-wires configurations needed to obtain best results and the genius idea about the use & modifications of the Sweet DTO (Diamagnetic Torsion Oscillator). Final detailed point will be about the full conversion event that led to the destruction of all devices connected to Otto's ECD coils.
2. Second part does report on a detailed study conducted with professional equipments that enabled both *Otto* and *Roberto* to understand step-by-step the events playing just in front of our eyes on ECD various dimensions demo units. This study has been done using a full photographic approach in order to certify in a way the job done. We made the test first on the 6" ECD and than on a fresh built 15" ECD.

Please be patient and read all from beginning, this is really necessary to get the proper mental frame necessary to understand what follows.

It is clear that this is only the first step, much work is to be done, we ask for the help of all interested in contributing in this ECD project.

A last think: ECD when operated close enough to full conversion point, will couple ether (?) into reproducible energy many magnitudes beyond what can be supplied through power supply. The power supply is only for driving the 3 oscillators, it has no connection with the gotten power from ether conversion! That is our understanding.

PART ONE

*Mobius ring setup, developing
&
optimizing*

2. INITIAL OTTO'S TESTS

2.1 50 TURNS-ON-TWO-FINGER EXPERIMENT

For this first test Otto did use just a quick & dirty setup using:

- small +12V dc P.S.,
- small coil wound on two fingers for about 50 turns of copper enameled wire,
- a piece of wire running freely inside that wound coil connected to the PS + 12V point trough a small 24V/5W light bulb.

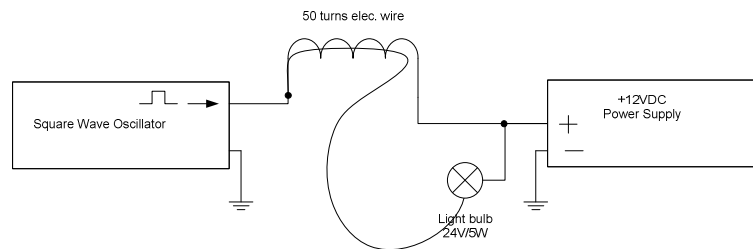

Fig. 1 - First 50 turns coil setup

And there came the sweet: even using this minimal approach he has been able to light somehow the connected lamp. So next automatic step was that of seeking to improve that idea. Of course the power delivered by a simple oscillator was so low and the delivered output pulse rise time (from the oscillator) certainly too long, so why not trying to interpose a top level very, very quick POWER MOSFET SWITCH and see what happen?

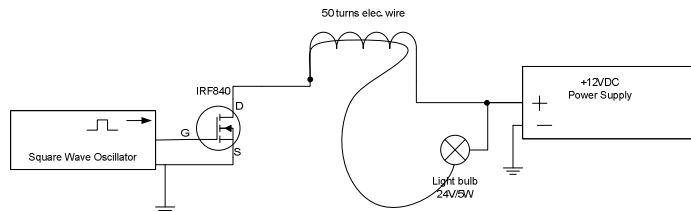

Fig. 2 - Improved 50 turn coil setup

It was totally clear that this setup was far superior. Then it was logical to try another extension as that to slide into another equal coils pulsing it in parallel way.

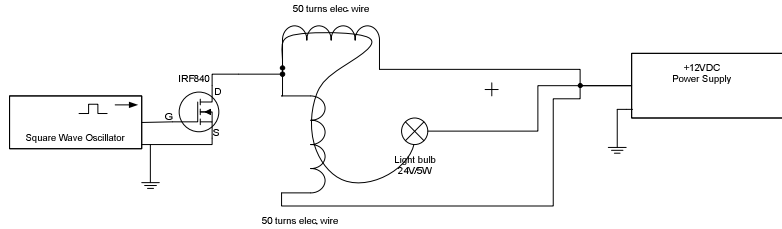

Fig. 3- Two coils setup

Again large improvement, but when tried with a 25W light bulb ...no power at all. So it was the time to try with a real Collector loop and the first question was: what wire diameter/section/material to use in order to obtain the best results (for us ...light)? So Otto set up a test bench for that purpose and used a simple tester to measure only Kicks amplitude (not absolute readings) to obtain an indication. It does follow the results table.

The tests in this run were conducted using a ‘soldering wire’ with 1 mm. diameter as electrical wire material and just cutting it in a progressive way.

SOLDERING WIRE USED FOR A COLLECTOR 1 mm. diameter		
Length (cm.)	Kicks amplitude (Volt)	Note
67	5,00	
65	4,97	
63	5,20	
61	5,80	
59	5,80	
57	5,60	
55	5,50	
53	5,58	
51	5,90	
49	5,75	
47	6,00	
45	6,10	
43	5,90	
41	6,40	
39	6,40	
37	6,30	
35	6,00	
33	7,40	
31	5,50	
29	5,40	
27	5,80	
25	4,80	
23	5,00	
21	5,40	
19	4,60	

Tabel 1

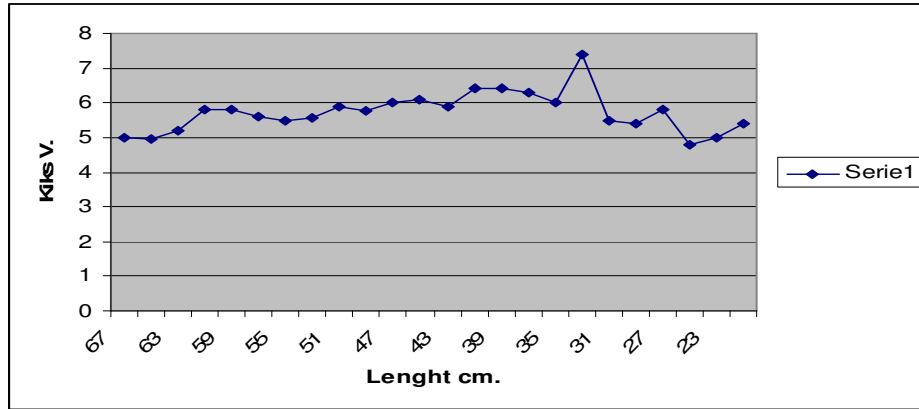

Diagram 1

It is clear that: for 'soldering wire' the best collector length is 33 cm. of length.

2.2 RING DIAMETER TESTS

Why make use of 6" ring diameter rather than 7" or any other figure? That is really very important. For example:

Note1:

collector length for 6" = 15.24 cm.

collector length for 4" = 10.16 cm.

Note 2:

Circumference perimeter for 6" collector = 47.85 cm.

Circumference perimeter for 4" collector = 31.90 cm.

So here is a table summarizing in terms of kicks output various length of various metals wires. Please do note that to lessen the measurements errors, the readings were taken 2 or three times.

COLLECTOR WITH VARIOUS METALS & LENGHTS 1 mm. diameter			
Length (cm.)	Kicks amplitude (Volt) for Solder Wire	Kicks amplitude (Volt) Aluminium Wire	Kicks amplitude (Volt) for CopperWire
67	5,50	5,80	5,10
57	6,75	6,20	5,40
47	7,00	6,00	5,20
37	7,40	6,00	5,80
27	7,00	6,90	5,80
17	6,75	5,75	5,40

Tabel 2

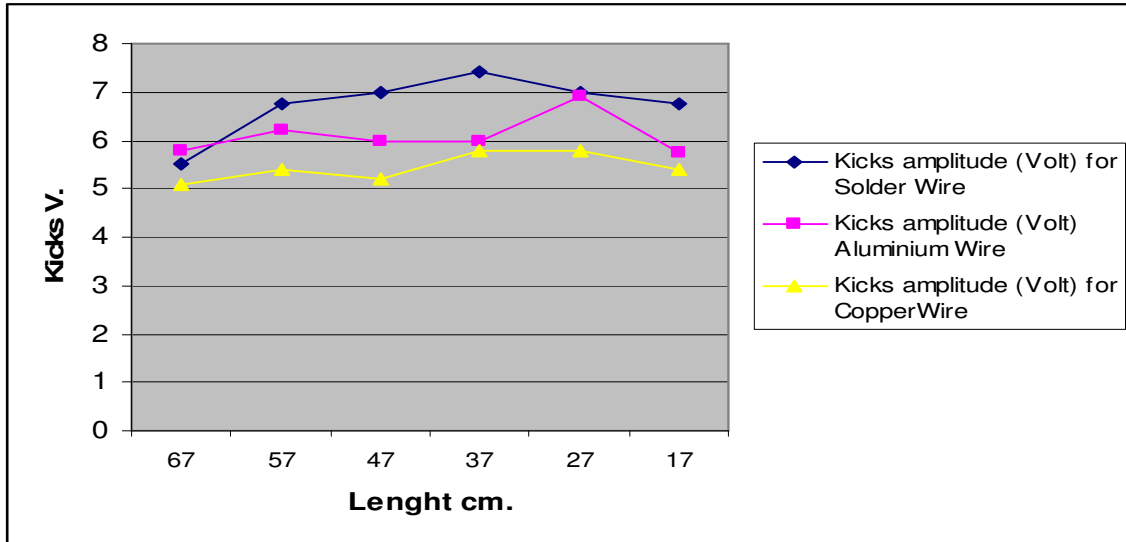

Diagram 2

So it was clear, looking at the tables, that there were different outputs for different lengths & metals. It generally appeared that ‘soldering wire’ (an alloy) was generally better than pure metals. So the most important test were made using the soldering wire.

With reference to the table 1 and 2 the rule to follow is that to have the max kick voltage difference between the two collector wires. So looking at the results it was clear the necessity to optimize the CC coil to do the job.

This was the time when Otto did post on Overunity Forum the ‘Wing approach design’ for the shape of the Control coil & and a practical approach for implementing & positioning of the collector coil itself.

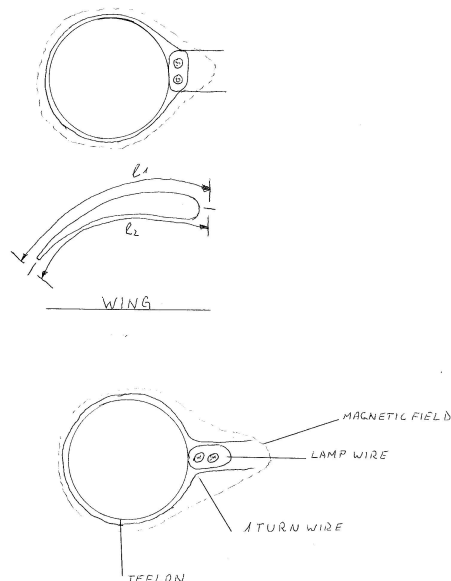

Fig. 4 - Wing profile & Collector positioning options

This is the proposed layout options of a 'lampwire' collector type glued directly onto the internal side wall of a Teflon/silicon hose of about 1 cm. of diameter. The overall shape is similar to a wing-shape with speed increasing near the collector wire position.

The preferred solution to increase the speed is to set the collector lamp-wire in an horizontal position like shown on 3rd image but the first one was also very good.

That kind of setup has been tested using just one CC and pulsing it with 1 - 10Hz range and +12V square waves with very good results: obtained a rotating magnetic field (checked suspending over a small magnet).

Please be careful with this kind of coils as they normally operate with high temperature - don't touch them.

3. BUILDING DETAILS

6" Mobius double wire loop

1. This coil loop is composed (in demo unit) by a single turn of standard lamp-wire (two isolated parallel .8mm copper strand wires) this just to ease the assembling.
2. After cutting the correct wire length you must prepare as well an equivalent length of silicon (or the like hose but able to support >100°C heat) hose 1 cm of diameter in order to setup a support structure for the lamp-wire itself.
3. Form the hose in a circle and fix it by inserting for example a wood inset between the two ends.
4. You have now to glue the lamp wire to the internal side of the formed hose loop. In demo unit we glued the lamp-wire to hose in a vertical way (horizontal would be best but is more difficult to do).

4" Mobius double wire loop

Just do the same done for the 6" unit but this time of course you have to put the lamp-wire on the **outer side** of the loop. This is to enhance coupling of the two loops.

Control Coils

You have to build 3. Each CC is a transformer so it has a primary and a secondary. In order to do winding you have firstly to prepare a suitable support structure. Remember that the structure must have a longitudinal inner hole to match the overall shape of the Mobius hose + lamp-wire assembly. When the CC are finished you will have to slide the e assemblies into the Mobius loop and position them at 120 degree.

Summarizing:

- CC structure width: about 1".
- Primary winding: you have to use 4.20 mt. length. And .5 mm. copper enameled wire.
- Secondary winding: you have to use 10.50 mt. length and .35 mm. copper enameled wire.

NOTE #1: the coils are parallel wound in a CW way. The primary wire will reach the end first as it is shorter. No problem you continue winding of the secondary wire till the end.

NOTE #2: Each CC has a starting and an ending, label on the support structure that wires as next you will follow always the same connection rule (I mean do not slide the CC on Mobius coil in a vice-versa way).

After completed the two wire loops assemblies, you have to put the small one into the larger one and start to do the connections. In Fig 8 you can see an 6" setup (note that the 6" is opened, that just for easy working on).

Hint:

We do suggest in order to avoid errors, to do like this:

1. Lay down on your work-bench the 6" assembly collector loop (1 cm. hose with the glued lamp-wire) leaving the 4 end leads (about 5 cm.) out.
2. Put the 4" assembly collector loop inside the bi loop leaving the 4 end leads out.
3. Connect the big loop lamp-wire upper wire, on left side, to the smaller loop lower wire left side.
4. Do the same for the 4 leads on right side.

You did the job without errors!.

4. SWEET DTO CONSIDERATIONS

After seeing the Sweet DTO diagram posted on Overunity Forum some points did auto-connect together and Otto find it necessary to do almost a full replication of the suggested device. With reference to the following diagram

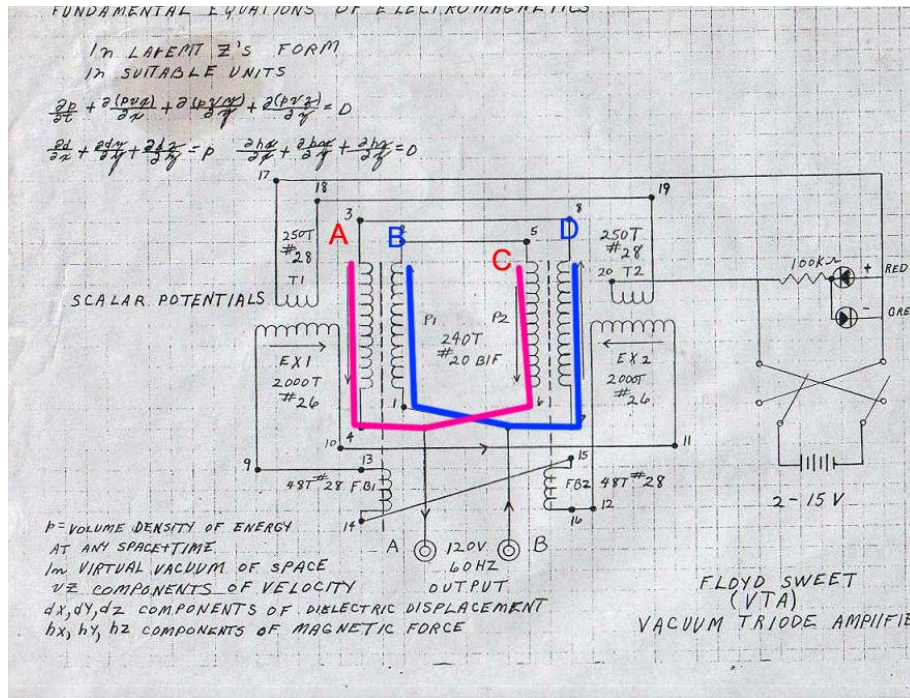

Fig. 5 Sweet DTO diagram as posted on³

When analyzing this collector coils (A,B,C,D) it becomes clear, that the coils A+C can be wound as one parallel-wire coil (i.e. from lamp wire) Same goes for coils B+D. One double coil CW, the other CCW, the immediate idea was to arrange each of these double coils in a circle, with both circles stacked on top each other or a smaller loop inside a bigger loop.

Before doing any development Otto did some tries according to Sweet indications, but no way to get anything from the output. It was natural to ask why? In order to be able to understand the evident Mobius connections Otto just tried with some equal length crossed wires collector like this:

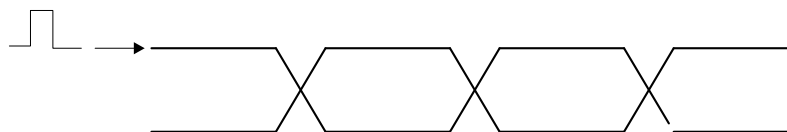

Fig. 6 wire crossings

³ <http://www.overunity.com/index.php/topic,2235.90.html>

With that kind of connections much better results were obtained. At the test's end it was clear that Sweet diagram was in a way wrong and there was the need of two end wires crossings like this:

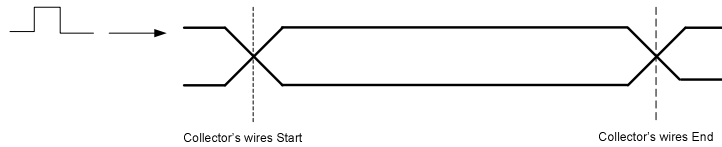

Fig. 7 Correct crosses approach

Summarizing:

Device DCV Input	Not fixed DCV but pulsed square waves.
Collector's Coils	Not single wire run but parallel wire run.
240 turns Collector	No need.
>2000 turns secondary	No need.
Iron core	No need.
Copper enameled wires	Alloys have special properties.

In a way the overall results where coherent with Table 1 & 2.

5. FIRST & FULL CONVERSION EVENT

Thinking to have got enough information I thought to setup a complete 3 CC on a 6" double Mobius ring & double crossed as in fig.

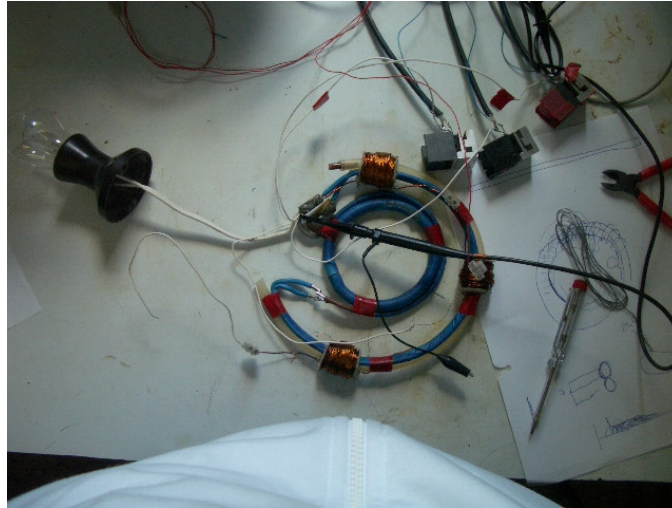

Fig. 8 Initial test setup

The main error was to not connect a suitable load on the output wires. So I started to pulse the coils in parallel with 3 frequencies and playing with this. The PS was delivering about 12V @ 2.5 - 3 A. Every thing was hot and I saw

A GRADUAL CONVERSION HAPPENING AS PIECES OF A PURE SINEWAVE

with only a little hash on the top. There were a lot of sine waves pieces that could be at-once fitted with the natural 'eye integration' so tried to clear the mess and doing more conversions just with the help of the 3 oscillators. The conversions were evident as in the very instant there was a big P.S. pumping effect in perfect synchronism. The more we advanced the conversion the clearer were the sine waves completed: It means that for each RE spike eliminated a new piece of sine wave was created so lessening the overall hash. Near the process end was left only a little hash on the top of the created sine wave. Being afraid, all the iron objects were taken out from the work-bench.

Suddenly after just a little oscillators adjustment a MONSTROUS pumping effect was evident with the instauration on P.S. of a full scale voltage oscillation at Shuman frequency and P.S. current indicator stable to 0. On scope screen the signal on the contrary was absolutely stable.

The pumping effect lasted for about 7 - 10 sec and then stopped. I got:

- Scope completely damaged.
- Oscillator output stage OFF.
- P.S. not damaged.
- Not one protection on P.S. activated.
- Protections on work-bench not activated.

So Otto was left with only an analog tester and a phase-check electrician screw-driver to go on. I discovered that it was possible to confirm the correct Mobius operating state (it happens only when pulsing with correct set of frequencies) just by probing it at the output points. It is from there that Otto started to label up mentioned points as: **PHASE** and **ZERO**.

So it was clear that the same techniques could be applied to check the CC: just probe the little transformer with the neon screw-driver on both of the coil's sides and soon discovered that there were different indications (the point to probe are: the input where you feed the pulses (primary & secondary coils) and the secondary coil endpoint). This means that different things were happening just on the same wire (think at the DC path equivalent circuit....all is shorted by the Mobius wire). This also led to necessity to connect in a separate way each wire in order to avoid to sink huge currents from PS.

Being the wires separated it where the moment to think why not separate the Mobius ring as well. After some tests it was found that for the 6" ECD there exists a vertical separation distance that does provide a discrete output increase. Of course something does happen just at this sweet point at distance equal to 44 mm.

Now it is clear that:

- 6" ECD is a correct figure.
- 44mm. is the correct vertical distance position of the 2 Mobius ring.
- the ECD wire-length used was correct.

Additional data on best Collector's length are as it follows.

5.1 COLLECTOR - TESTS WITH VARIOUS METAL WIRES

Collector - Tests with various metal wires

Testing conditions:

Coil	<ul style="list-style-type: none"> • Wire diameter 0.3 mm. • Turn's number 140 • Coil diameter 21 mm. • Winding method: 1 layer
Scope setting	20 microsec.
P.S. Setting	12.5 V
Used metals	<ol style="list-style-type: none"> 1. Aluminum wire 2. Copper wire 3. Soldering wire 4. Stainless still wire
Length of the wire	5. 67 cm.

The test setup is shown on next Fig. Overall results are (output in relative Volt):

Metals	Kicks(1 mm. wire)	Kicks (2 mm. wire)
Al	13	
Cu	13	
SS	16	
Soldering-wire	23	21

Tabel 3

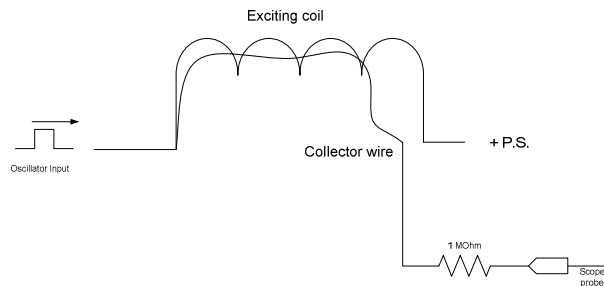

Fig. 9 Collector output setup

What still needs to know is the rationale behind the CC transformer design.

5.2 CONTROL COIL TRANSFORMER OPTIMIZATION

5.2.1 Primary side tests

An idea about wires properties are already known⁴ (remember the Kicks voltage readings are to be interpreted only as a relative indication not an absolute reading, actually they were obtained putting a 1 MOhm resistor in series to scope's probe).

⁴ Look at tables 1, 2

Tests with various metals & lengths

The following test are made pulsing the same circuit (Fig. 7) with the same frequency but varying the wire composition and the wire length. The reported output is in Volt.

Metal wire	140t	130t	120t	110t	100t	90t	80t	70t	60t
Cu (1mm)	5,3	7,05	7	6,5	7,2	6,6	5,8	7,3	6,0
Al	6,1	7,2	6,95	6,6	6,6	5,8	6,3	6,2	6,5
Sold-wire	6,1	7,5	6,5	8,4	6,0	5,8	6,0	6,25	6,05

Tabel 4

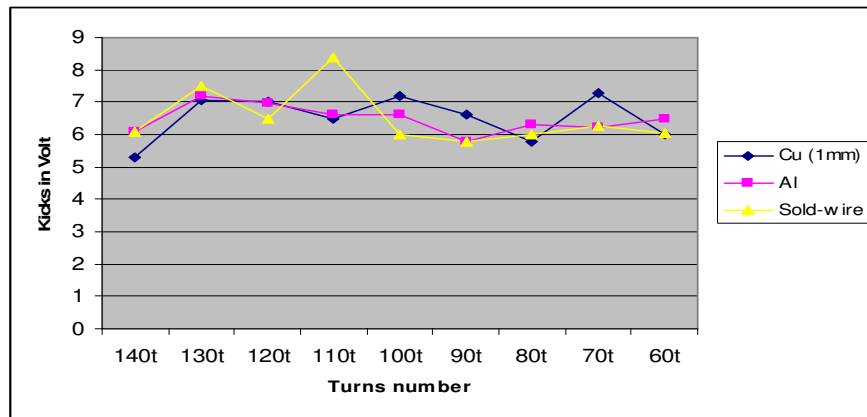

Diagram 3

It is evident that still soldering wire, for a unique length, is far superior but it is necessary to remember that the alloy does show a very low melting temperature which could be dangerous for the ECD operation.

Another fact is the appearing, for Al and Cu, of a sinusoidal shape that could bear a significance. So it's clear that is necessary to look for a rationale.

What it follows is a detailed study on Control Coils - primary side tests.

Testing conditions:

Wire diameter	0.5 mm.
Collector Lamp-wire lenght	47.8 cm.
Power Supply setting	12 - 13 Volt
Operating frequency	100 - 300 KHz.

Wire Length (mt.)	AC Output (Volt)
7,00	49,00
6,80	50,00
6,60	50,00
6,40	51,00
6,20	51,00
6,00	53,00
5,80	55,00

5,60	56,00
5,40	57,00
5,20	57,00
5,00	57,00
4,80	58,00
4,75	58,00
4,70	59,00
4,65	59,00
4,60	59,00
4,55	59,50
4,50	59,5
4,45	59,5
4,40	60,0
4,35	60,0
4,30	60,5
4,25	61,0
4,20	61,0
4,15	61,0
4,10	60,5
4,05	60,5
4,00	60,5
3,95	60,0
3,90	60,0
3,80	59,5
3,70	58,0
3,60	58,0
3,60	58,0
3,50	57,5

Tabel 5

Best result: 4,20 4,25 m. -> 61 Volt

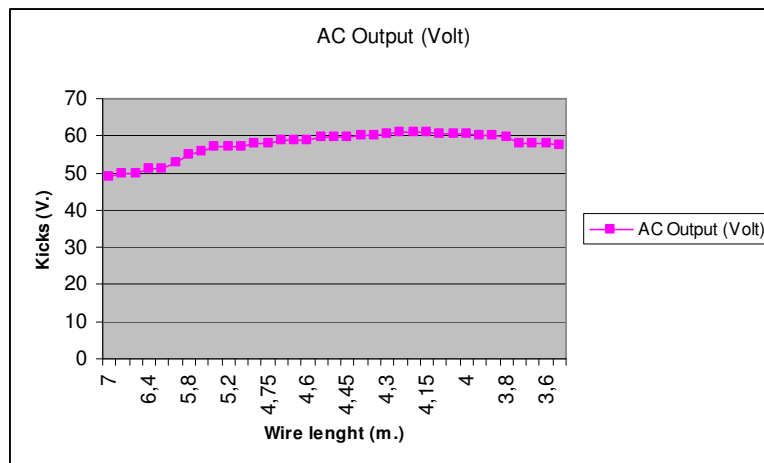

Diagram 4

Testing conditions:

Wire diameter	0.65 mm.
Collector Lamp-wire lenght	47.8 cm.
Power Supply setting	12 - 13 Volt
Operating frequency	100 - 300 KHz.

Wire Length (mt.)	AC Output (Volt)
6,85	47,00
6,65	47,00
6,45	48,00
6,25	49,00
6,05	50,00
5,85	51,00
5,65	52,00
5,45	54,00
5,25	55,00
5,05	55,00
4,85	55,00
4,65	55,00
4,55	55,00
4,45	56,00
4,40	56,00
4,35	57,0
4,30	57,5
4,25	58,0
4,20	58,0
4,15	57,0
4,10	57,5
4,05	56,5
4,00	56,5

Tabel 6

Best results: 4,20 - 4,25 -> 58V

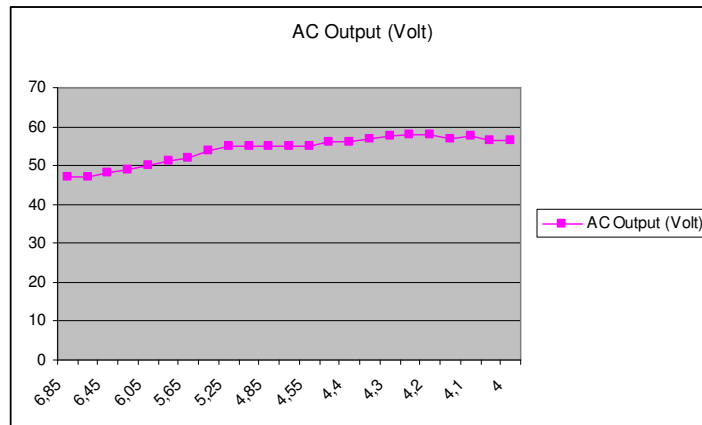

Diagram 5

Testing conditions:

Wire diameter	1 mm.
Collector Lamp-wire length	47.8 cm.
Power Supply setting	12 - 13 Volt
Operating frequency	100 - 300 KHz.

Wire Length (mt.)	AC Output (Volt)
6,00	75,00
5,90	75,00
5,80	75,00
5,70	77,00
5,60	77,00
5,50	78,00
5,40	79,00
5,30	80,00
5,20	80,00
5,10	80,00
5,00	80,00
4,90	81,00
4,80	82,00
4,70	83,00
4,60	83,00
4,50	83,00
4,40	84,00
4,30	85,00
4,20	85,00
4,10	83,00
4,00	82,00
3,90	81,00
3,80	80,00
3,70	80,00
3,60	80,00
3,50	80,00
3,40	80,00
3,30	80,00
3,20	80,00
3,10	81,00
3,00	82,00
2,90	83,00
2,80	83,00
2,70	82,00
2,60	81,00
2,50	81,00
2,40	81,00
2,30	81,00
2,20	80,00
2,10	79,00
2,00	78,00
1,90	77,00

Tabel 7

Best result: 4,20 - 4,30 m. -> 85Volt

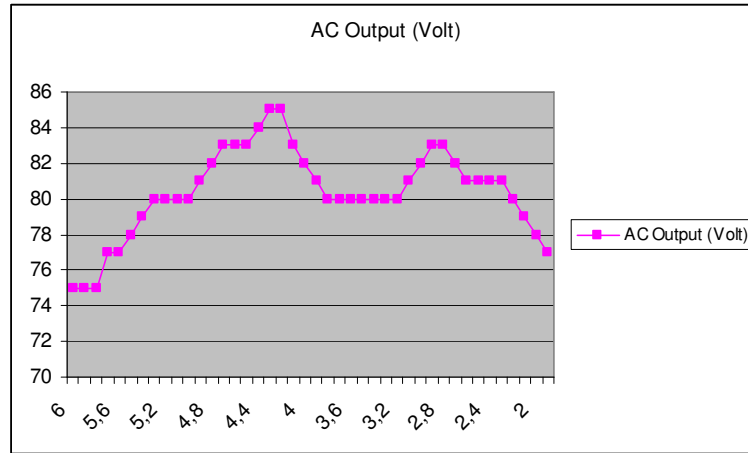

Diagram 6

Overall results with various length & wire size have a peak for 4.2 - 4.3 m. for wires diameters ranging from .5 to 1 mm.

Note that, as previously said, all the tests were done with the same frequency chosen in the range 100 - 200KHz for best lamp light.

5.2.2 Secondary side tests

The test was run using the same up mentioned conditions. The purposes was:

1. Turns ratio for the best result.
2. Right wire size for the best result.
3. Best winding method for the best results.
4. Inspecting if any unusual conditions.
5. Finding if Hi Freq coils implementing methods could be applied.
6. Finding if wing shape support coil structure method is always applicable.

Point #1 & 2

After running many tests, look at following tables it turns out that nothing changes in a noticeable way. The tests were done to find eventually a sweet point where max lamp light and min input current.

Testing conditions:

Wire primary	0.65mm., 4.20mt.
Wire secondary	0.35mm., 16mt.
Collector Lamp-wire length	47.8 cm.
Power Supply setting	12 - 13 Volt
Operating frequency	100 - 300 KHz.

Wire Length (mt.)	AC Output (Volt)
16,00	160,00
15,80	160,00
15,60	160,00
15,40	160,00
15,20	160,00
15,00	161,00
14,80	161,00
14,60	162,00
14,40	165,00
14,20	166,00
14,00	169,00
13,80	170,00
13,60	170,00
13,40	170,00
13,20	163,00
13,00	170,00
12,80	170,00
12,60	170,00
12,40	170,00
12,20	170,00
12,00	170,00
11,80	170,00
11,60	170,00
11,40	170,00
11,20	170,00
11,00	170,00
10,80	170,00
10,40	170,00

10,20	170,00
10,00	170,00
9,80	170,00
9,60	170,00
9,40	170,00
9,20	162,00
9,00	160,00
8,80	158,00
8,60	153,00
8,40	150,00
8,20	145,00
8,00	140,00
7,80	136,00
7,60	130,00
7,40	125,00
7,20	120,00
7,00	115,00
6,80	110,00
6,60	105,00
6,40	100,00
6,20	97,00
6,00	94,00
5,80	91,00
5,60	88,00
5,40	84,00
5,20	80,00
5,00	75,00

Tabel 8

Best result: 9,40 - 13,00 mt. -> 170Volt

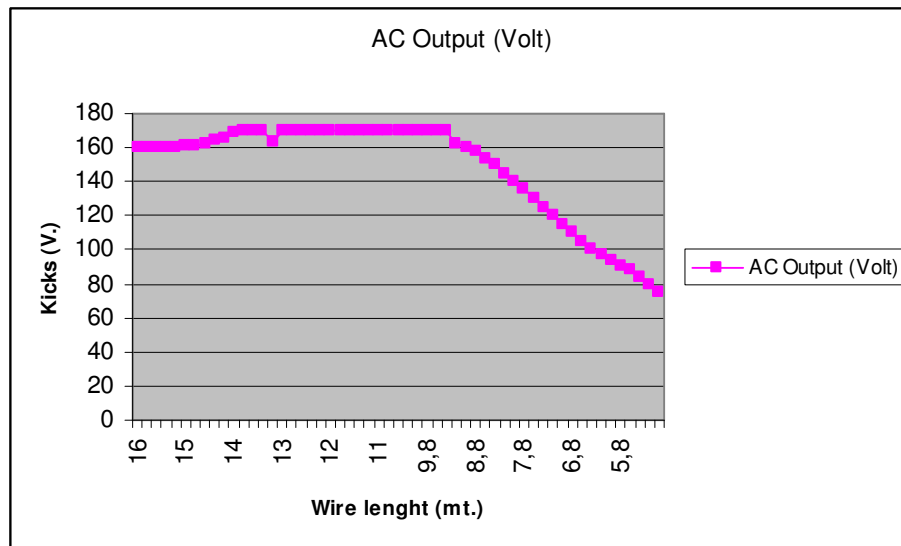

Diagram 7

Point #3

The first try was to wind 50 turns on two fingers and an additional separated coil to simulate a secondary coil just to get an idea of the output. The light bulb (25W) where connected one end to PS (+ 12V) and to the secondary end lead.

In the first, with coils somehow separated, the bulb where shining strong, then suddenly no light at all. Light where restored only pressing the two coils together. Now it

was clear what to do to have a correct winded Xformer: just put as near as possible the primary and secondary wires. Of course the best readily available method where to run them in a parallel way.

Perhaps a possible advanced technique is that to use Litz wire with at least 40 isolated strands and fraction the coil itself in few little vertical run coils in order to lessen the stray capacitance and hence get a wider bandwidth that could translate in our case into a faster response and bigger RE spikes.

Point #4

From previous tests we have got a best wire length of about 4.20 m. and 1:1 turns ratio Trying to use other turns ratio like 1:2, 1:3, 1:4 -----1:7 led to nothing so it's clear that something else is going on.

It seems that using higher turns ratios, the longer wire just gives more stray capacitance so the overall coil speed is lower. It is clear that we have to choose the right trade-off point from previously shown tables.

Point #5

There is a thinking: why do not try to resonate the coils? Answer: there is not any necessity to resonate the coils as we are looking & optimizing for speed and non linear operation.

Point #6

The many test already done confirmed that the wing profile coil support structure is the best for our purposes.

Point #7

Please look at Point #4 reply.

5.3 MOBIUS BASED ECD - A STUDY

Looking at the Sweet DTO (Diamagnetic Torsion Oscillator) on Fig. 6 (device posted on Overunity Forum) firstly Otto had the impression that it was right good for our purposes, many of the features described were indeed coherent with many of our efforts to replicate the SM design but, as previously said, some adjustments were needed, mainly what necessary was to translate it into the TPU framework, this means:

1. No iron coils.
2. Pulse DC input rather than using fixed DC level.
3. Using just only 1 turn for the collector.
4. Using much less windings on secondary coils, this because we are not looking for a 'transformer' action.
5. Looking at the 'cross coils interconnections' it is clear that they resemble a Mobius well known scheme, so have a look at fig 5 & 6: with 4 crossings no way to get any output. The next test was just to use 2 crossings and that's OK, obtained lot of output. So it was also the idea to use 2 Mobius collector rather than one just to see what could happen. **The final and actually in use setup is: 2 Mobius loops crossed twice.** This setup is shown in the next picture for the 6" - 4" ECD. In the Fig. you will note: the 2 Mobius collector loops one inside the other (glued to the side of a silicon hose used as support & shape), the 3 small transformers 120° apart, the heat sinks & Mosfets put near the loops, the wing shaped solution for the coil support.

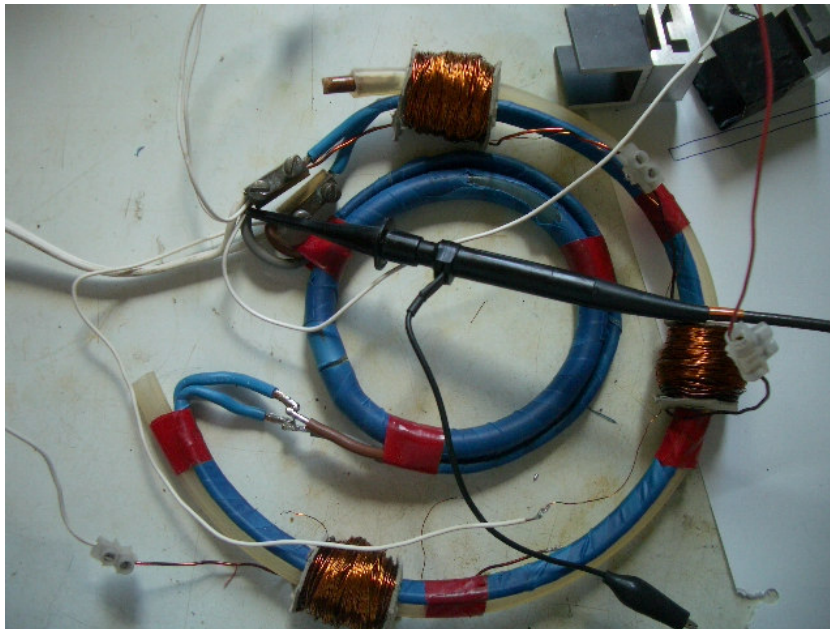
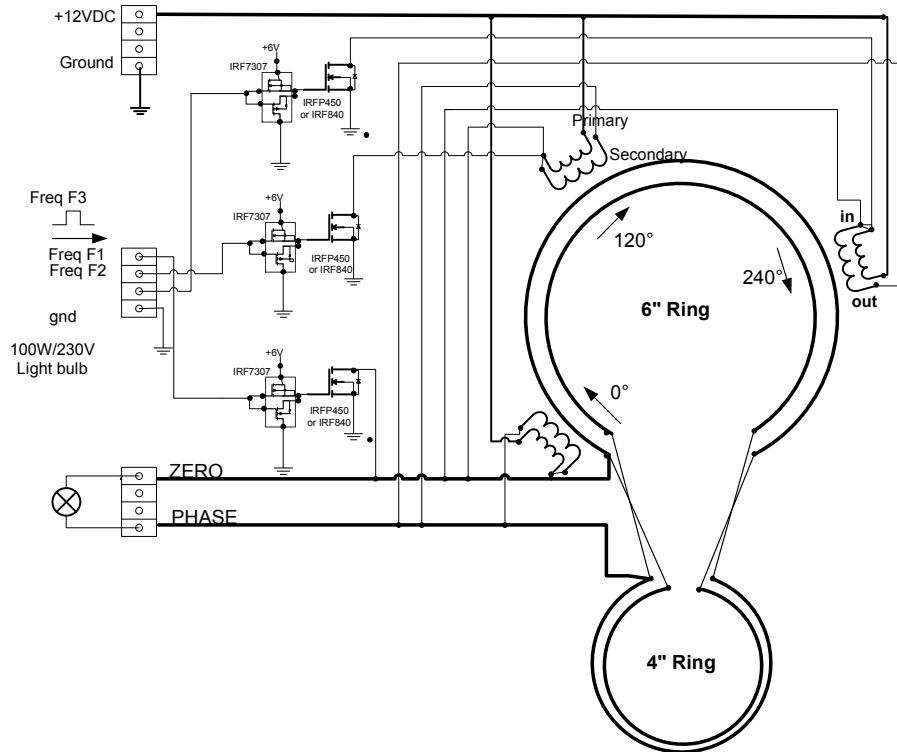

Fig. 10 Final 6" 2 Mobius coils twice cross-connected

It follows the final operative project referenced in Part #2, showing the 2 Mobius loops separated, actually the smaller (4" wide) loop must be rotated inside the bigger loop (6" wide) like in Fig. 8 as there must be a coupling between the loops. Of course the actual lamp wire collector must be put on the inward side of the bigger silicon hose and on external side of the smaller silicon hose 4" collector to allow for adequate inter coupling.

Again, as previously said, the 6" loop should be also set in a position over the small one at exactly 44mm. in order to obtain additional output.



Title ECD Mobius diagram		Revision: 1.0		Note#1: The 4" ring must be routed into the 6" ring. Note#2: the two Rings are built using standard lamp-wire i.e you can use any parallel-run kind of wires. Note#3 CC transormer coils are built according the study in this document. Note#4: the CC transormers are pulsed in a CW direction (in>out), they should be pulsed CCW.
Original date:	SCALE:	N.	DATE Description	
LAST REVISION 08.06.2007	Job No:	VERIFICATO ronotte	DISEGNATO ronotte	

Diagram 8 Final ECD setup

This setup may appear a little odd as if you look at the DC equivalent circuit: all is connected together. This could be a misleading fact. Actually this unit does have a complex operation not so clear till now.

A fact is that if you put in derivation on the load (light bulb 100W/230V) 2 scope probe, as you will see in Part 2, you will find together: fixed DC level, pulsed DC square waves, RE spikes also summing each other on pulse leading edge, AC pure signal in pieces or completely formatted all in the first quadrant, hash.

If you look at the 3 frequencies pulse input in diagram 8, you will see that the input themselves are connected together in a sort of what I call: '**Wired AND**'. This means that instant by instant the net signal on the coils is determined by the logical AND of the 3 asynchronous waveforms. Of course in this way the operating waveform is not of deterministic kind. In my opinion the next step will be just to input synched frequencies that will ease a lot all the adjustment technique, not speaking about power. The CC connection showed is in 'parallel way' in the sense that all the secondary coils lead are paralleled in two points labeled: 'ZERO' and 'PHASE'. You will see that some test was conducted as well with series secondary connections.

Another point: as you see the CC are pulsed in a CW way, actually should be in CCW way but there has not been time to do so. All the tests run in Part #2 will be with shown setup with coils pulsed in CW way.

Detailed suggested Oscillator design will be added later. For now the MOSFET's driving is to be considered important, all details about it may be read on *Roberto Notte* document 2magclashTPU.pdf freely available on Overunity.com Forum⁵.

Note:

Don't try to drive the power MOSFETs directly with your own oscillator (unless you are sure they do deliver nanosec rise-time and a suitable low impedance & power), generally it appears they are doing the job but actually they are not able to charge as needed the MOSFET's Gate capacitance and hence they do operate...but slow (as they don't go in the avalanche mode)...so no way to obtain what described in this report.

⁵ www.overunity.com/index.php?topic=2240.msg33606 - 2magclashtpu-V1_3_2_1.pdf

PART TWO

ECD
testing & understanding

By Otto Sabljarić
&
Roberto Notte

6. INTRODUCTION

After the full conversion event that led to damaging of almost all the Otto's equipment there was of course a stop due to the impossibility to do anything.

At this time *Roberto Notte* contacted *Otto Sabljarić* and soon after went to his laboratory for 7 days to help him in fixing the damaged equipment and running together a complete set of live tests.

Said philosophy, joining two very different way of thinking, really with our great surprise led us to see many fundamental aspect till now gone unnoticed and to an almost full understanding at least about the phenomena that were playing in front of our eyes. This kind of cooperation proved also useful to speed-up all the test-work. We were excited and worked on a day-night schedule till obtained wanted results/documentation.

What it follows is a complete living log about a series of tests and techniques applied to full understand the events. You will see that during the tests we stumbled into several additional Breakthrough.

6.1 TESTS WITH 2 CC WITH SERIES SECONDARY CONNECTION

Batch #1	
Date	05.31.2007
Start time	9:53 AM
CC	2 with secondary in series
Freq	1,2

This batch started at 9.53 AM with F1=40 KHz. The scope probe on ZERO point, 60W/230V light-bulb connected between ZERO and PHASE points. The scope zero-level is set on the screen bottom line. CC temperature about 40°C.

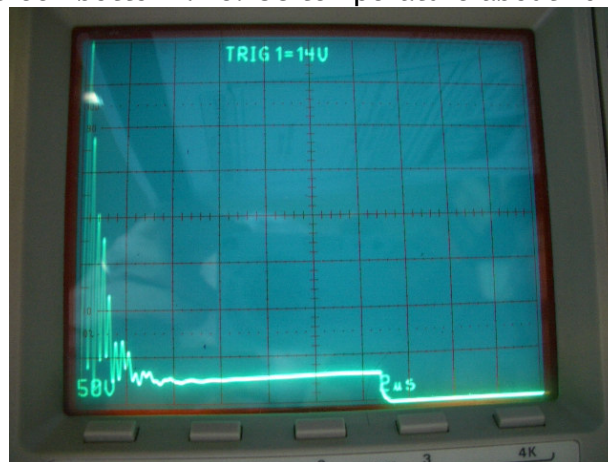

Fig. 11 RE peaks summing on leading pulse edge with 1 Freq.

In this picture (11) is evident that RE spikes (about 400V max) are sitting on the waveform leading edge just on top and lasting for about 2 μ sec and partially summing- up themselves.

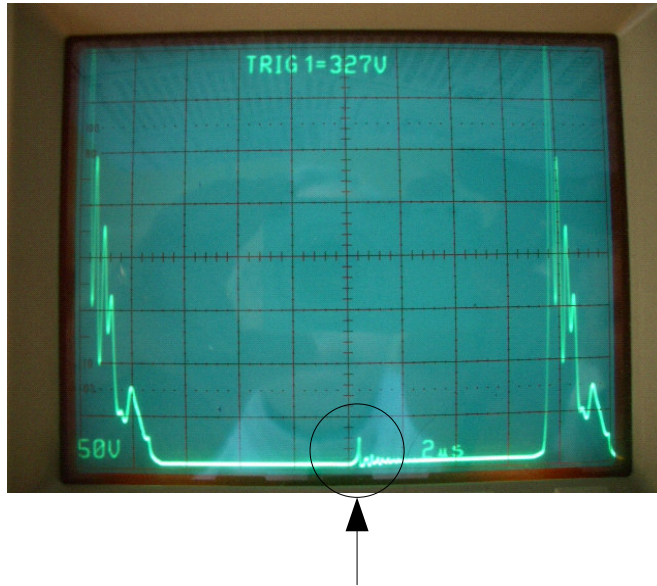

Fig. 12 ZERO POINT - RE peaks summing on leading pulse edge with 2 Freq.

On fig 12 we pulsed the 2 CC coils with 2 freqs, the probe on the first MOSFET Drain, scope zero level on bottom of the screen, CC temperature about 50°C. It appears that the main RE peak amplitude increased to about +500V (out of the screen) and the peaks summing effect much more strong.

Please look at the artifact on the baseline: what do you think is it? Well on the first we thought just it was just hash. Later I'll show the meaning...one of the secret of this Breakthrough.

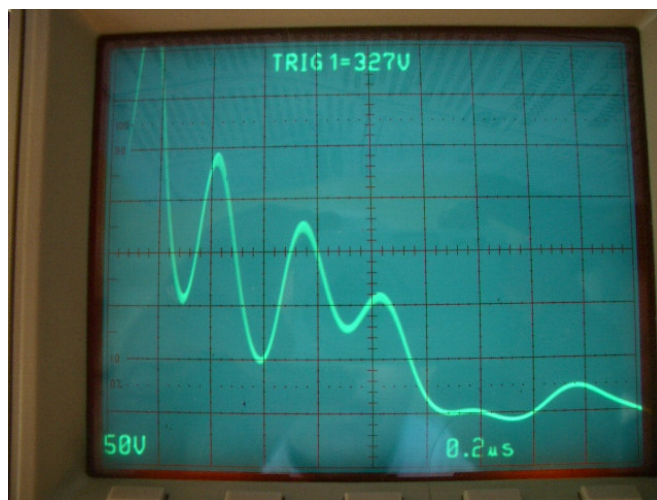

Fig. 13 An enlargement of fig. 11

You can see more info about RE peaks:

- Peak's summing is evident.
- Resonance is about 3.3MHz. This appear now as an NMR typical dumped waveform with 4 - 6 oscillations.

What follows is the signal actually on both MOSFET's gates, they do seem synched, but they are not.

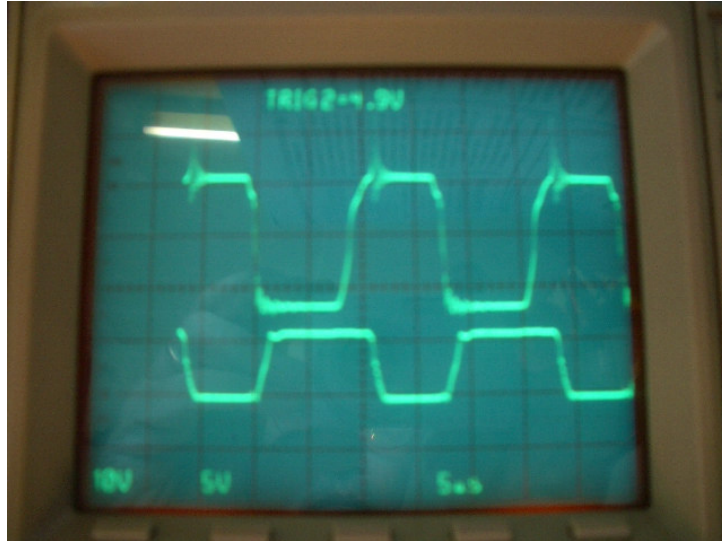

Fig. 14 Signal on MOSFET's gates

Following pictures (15, 16)) are taken after putting scope probe on 'PHASE' point, the 0 scope level is set to top screen line. The waveform in this case is all in the 4th quadrant (all negative) and symmetrical but somehow different from that taken on 'ZERO' point (compare with fig.11).

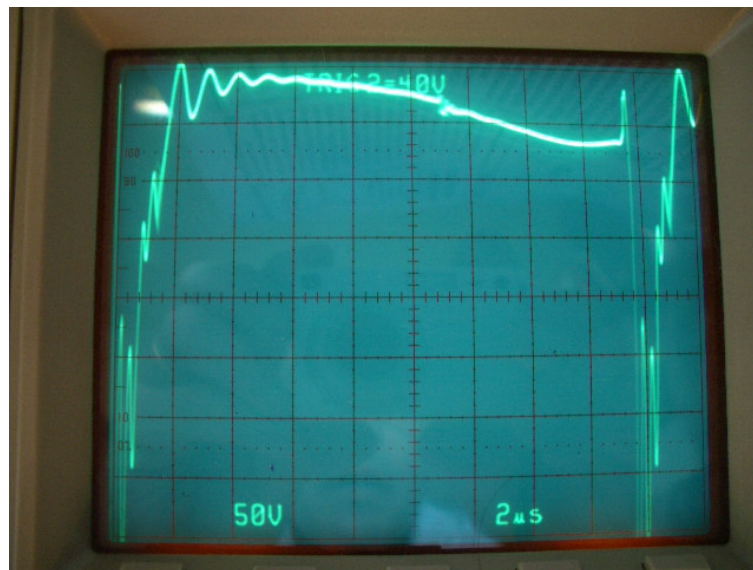

Fig. 15 PHASE point - RE peaks summing on leading pulse edge with 2 Freq.

Overall amplitude is about -500V and the peaks connecting line is no more straight but....start appearing something like a sinusoidal waveform. Please take also note that there is still the small artifact on the center of the sinus. What it follows is an enlargement of fig 14.

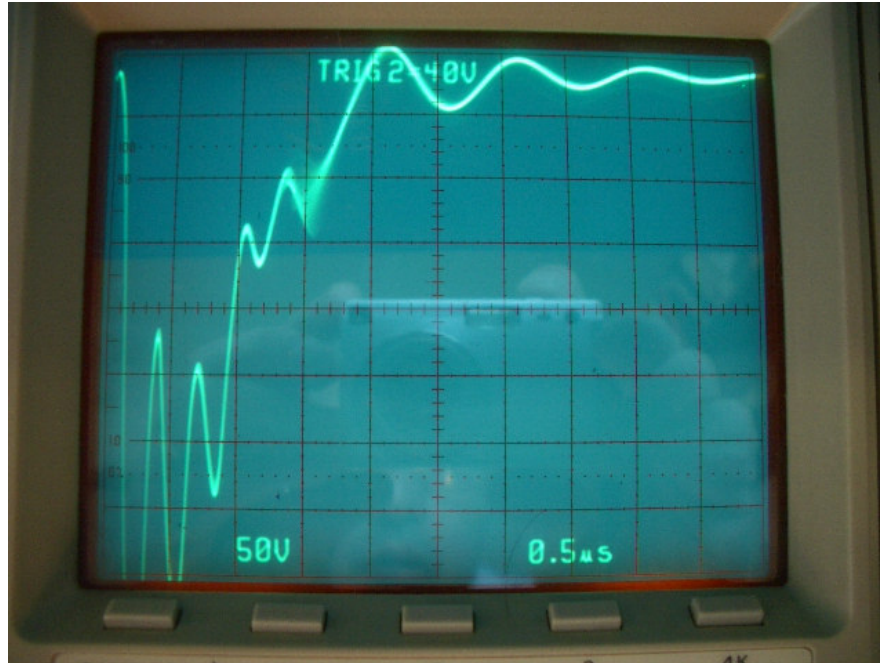

Fig. 16 Time enlargement of Fig. 14

Batch #2	
Date	05.31.2007
Start time	11:12 AM
CC	2 with secondary in series
Freq	1,2,3

Let us now use 3 frequencies adj (on both CC are applied 3 frequencies) and put the probe on ZERO point. Zero scope level is on bottom line.

This picture is fundamental, please give it the attention it deserves.

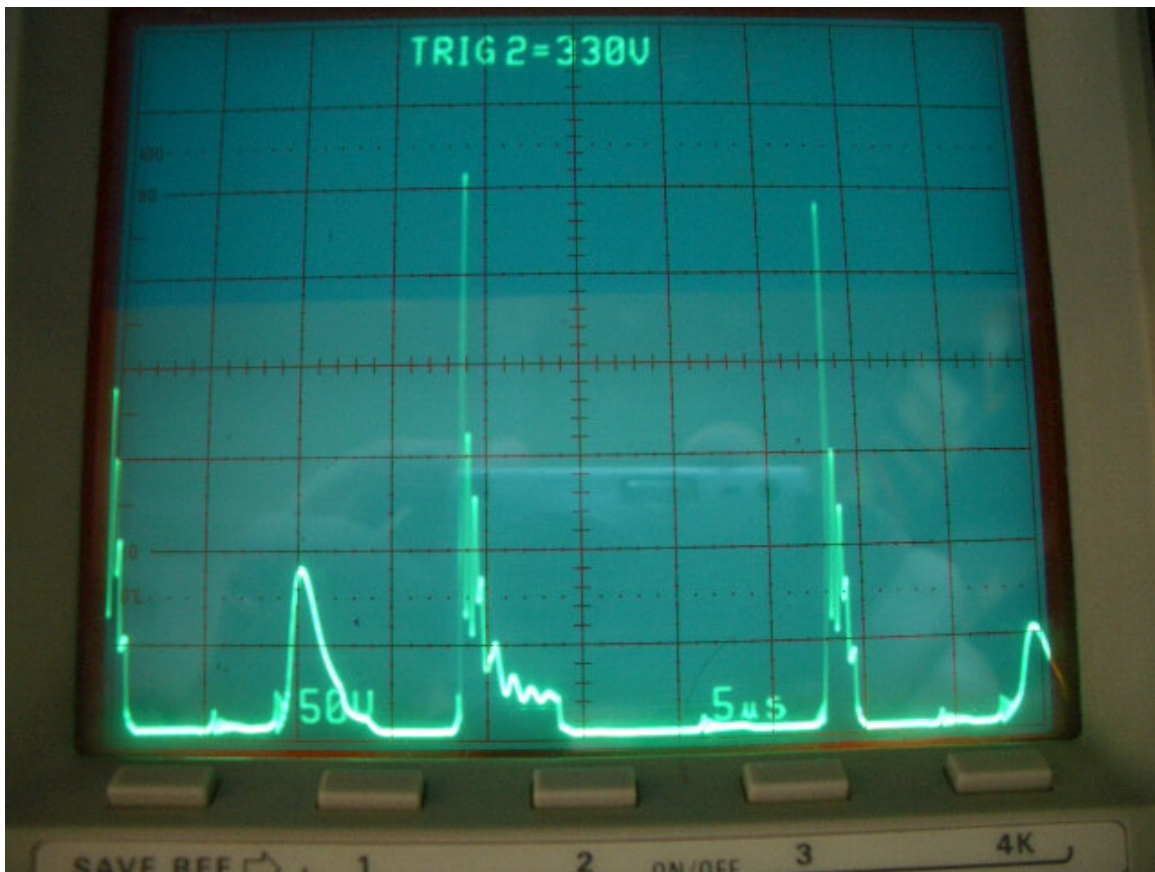

Fig. 17 Start of Conversion process.

The situation as we have after discovered is to be interpreted like this:

1. it is possible to see, starting on the left a first RE 'special peak' followed by a small artifact that from now on we will call the 'Seed',
2. there's another Seed just on the start of a piece of a sinusoidal wave; well that Seed is just 'CREATING' the piece of sinus!! In this process (not possible to show in a single frame but easily seen if filmed) the Seed does swallow a single 'special peak' that was in that same location by converting it in a piece (about +100V) of sinusoidal waveform. It seems incredible but believe me: it was right so showing in front of our eyes.

3. It follows a DC pulse +RE spikes and then again one Seed followed by a still 'special peak' that could be converted just adj the oscillator with lowest range (F2). Varying F2 does actually slide from left to right the Seed.
4. then another Seed and another Seed doing another conversion (at screen right end).

Here it follows another picture for the highest applied frequency and referencing Gate signal (on top) and ZERO signal (on bottom waveform).

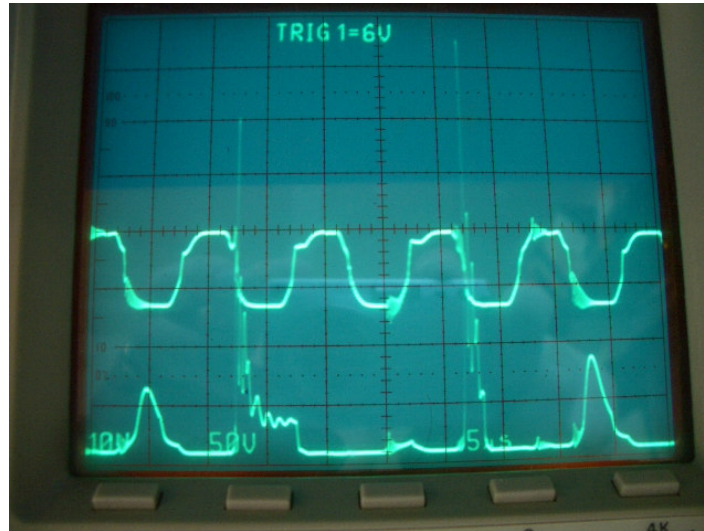

Fig. 18 Time relation between ZERO and F3

With it follows is just another Conversion example (every 4 input cycles).

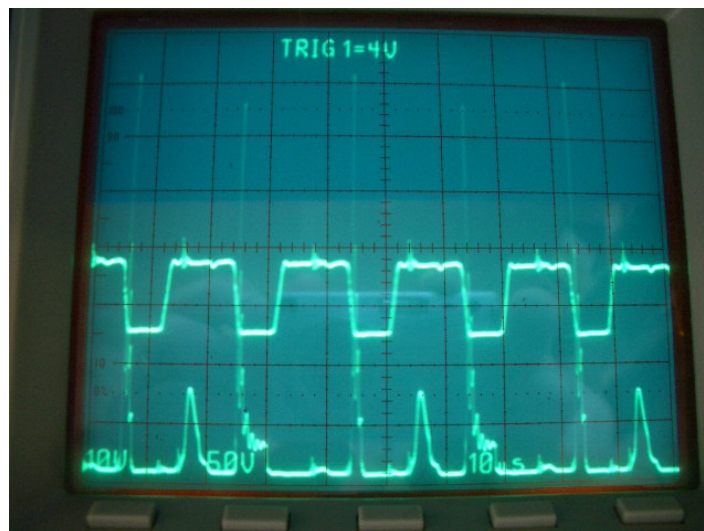

Fig. 19 Time relation between ZERO and F3

In this case we have conversion every 3 input cycles.

Summarizing:

It seems that we are experiencing a partial Energy conversion into sinusoidal pure wave every 3 or 4 input cycle.

In following picture we will try to show you in more details the creation process. Looking at following picture we can see 3 pieces of partially converted sinusoidal waveforms taken on ZERO point.

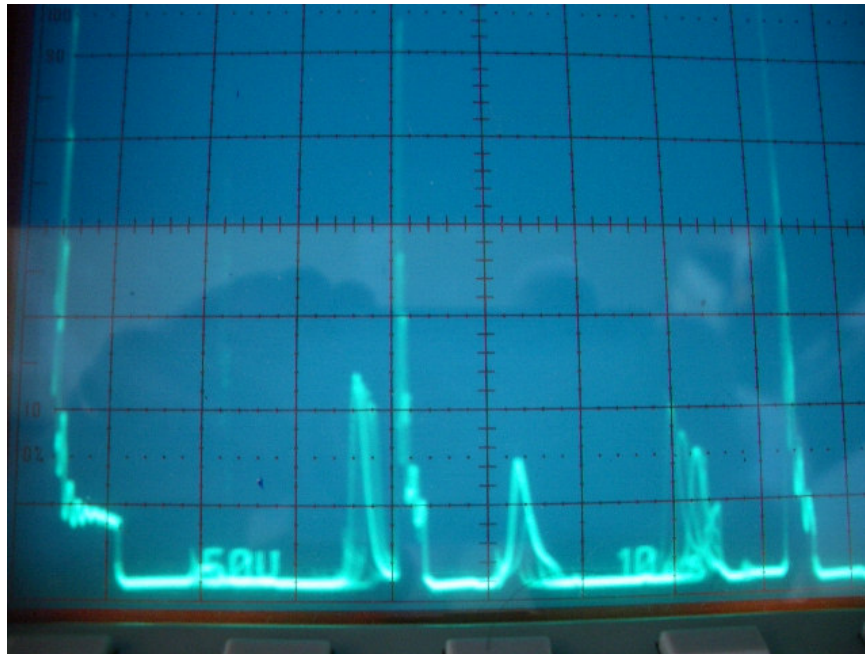

Fig. 20 Detailed sinus forming

You can see on the left that:

1. at 35 μ sec there's a almost complete formed big sinus that it's trying to swallow a near 'special peak' (to get bigger and more well formed...), peak sinus amplitude > +110V (zero Dc scope level on bottom line).
2. at 60 μ sec there is forming a sinus,
3. at 80 μ sec there is the clear indication of a new sinus forming by the Seed in it's left side (just near the sinus start point) . Of course the picture is blurred as there is work-in-progress and the scope synchronism is not able to catch on!

In this case the 3 input freqs were:

- F1 = 27.77 KHz
- F2 = 60.606 KHz
- F3 = 52,631 KHz

Now you can see a more refined freqs adj leading to the next picture.

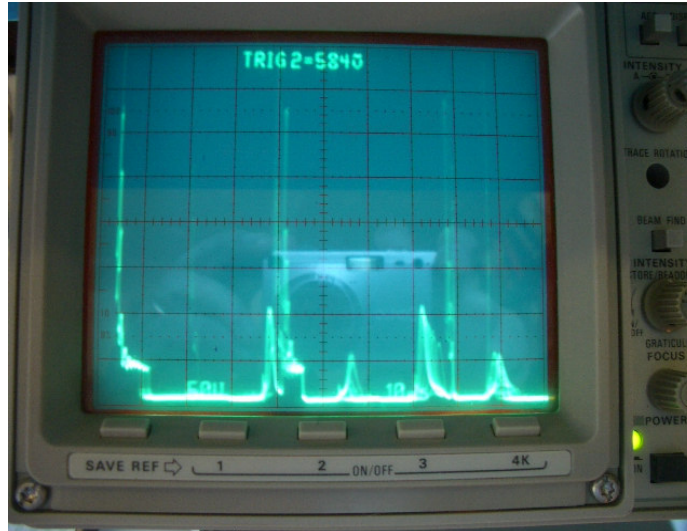

Fig. 21 3 created sinus

In this picture you can see 4 sinusoidal waves at various creation state: 2 well formed and 2 in creation. There it follows next freqs adj.



Fig. 22 Peak incorporation

It seems that a sine wave is very near to the second peak just being incorporated in it. At this moment this is the light on a 100W/230V light bulb.

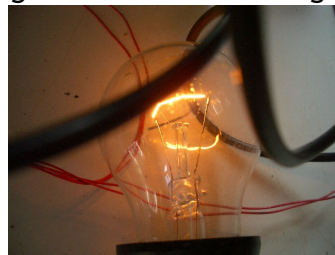

Fig. 23 Light bulb 100W/230V

After adj again the 3 freqs we do obtain following situation.

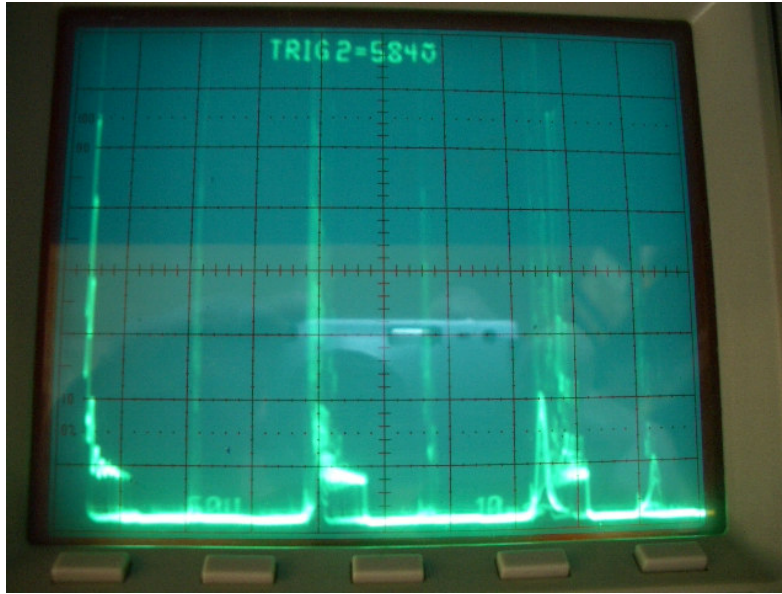

Fig. 24 Sine waves incorporating peaks

It appears that:

1. the first sine wave has joined the second kick,
2. the second sine wave is now near the 3d kick,
3. we do see a 'pumping' effect on PS analog voltage meter (voltage goes up & down from +12 to +21V @ Shuman freq).

Continuing to refine the 3 freq settings, when you are near the correct sweet point we note that the PS is less tampered with and voltage indication return to normal level (+12V).

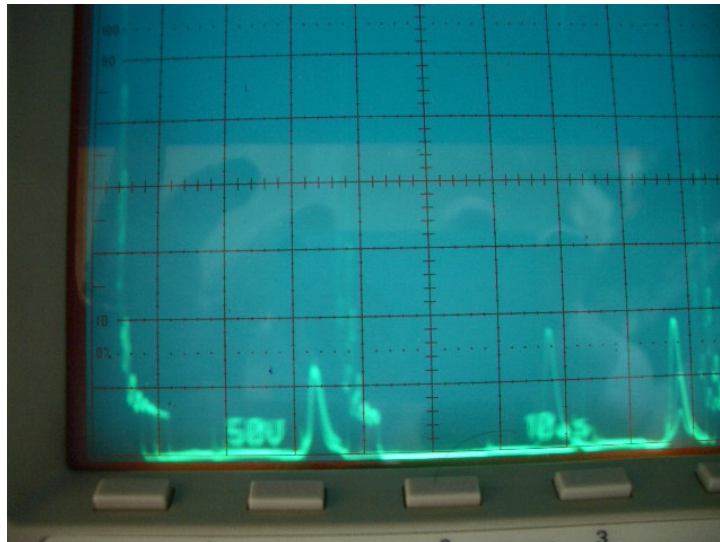

Fig. 25

Now we clearly see that there is indeed a stable sine wave just near the second kick and near the 3rd kick and a just starting another sine wave between the second and the 3rd kick.

SO WE FINALLY HAVE MORE THAN 100V SINE WAVES USING ONLY 2 COILS

Here's the light-bulb brightness.



Fig. 26 100W Light bulb brightness with 2 CC

In following picture you can see even better the sinus wave after a small freq. refinement.

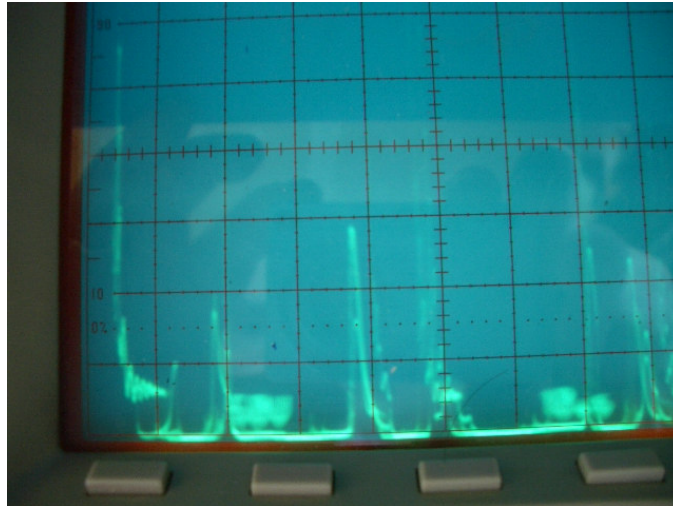

Fig. 27 (05.31.2007 - 13:26) Advanced 2 coil freq adj

You can see that the sine wave peak amplitude now is **about +140V** (look at screen center). Other peaks were completing the conversion process.

What is following are just better pictures taken enabling Peak detector & storage of the scope..

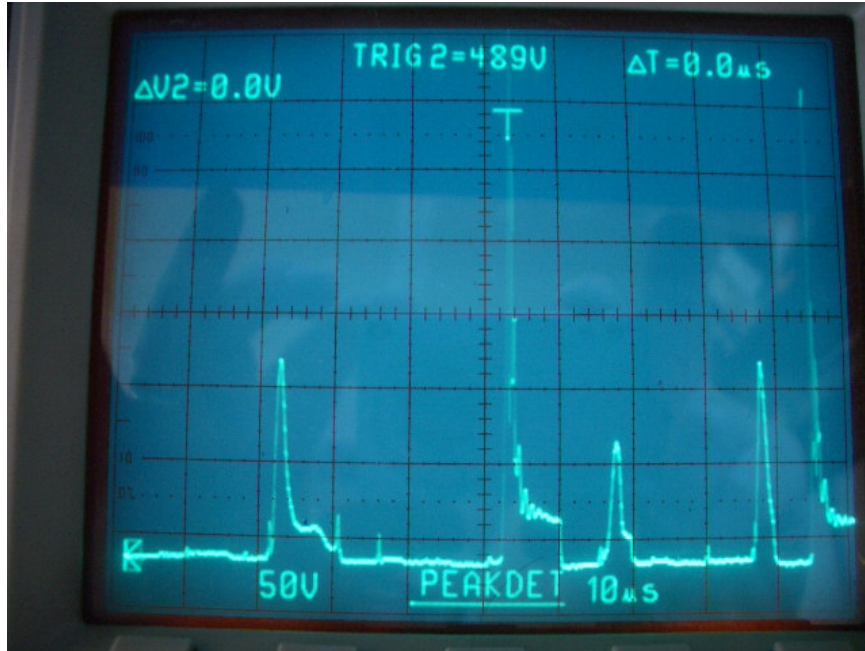

Fig. 28 (05.31.13:32) Various partial converted kicks

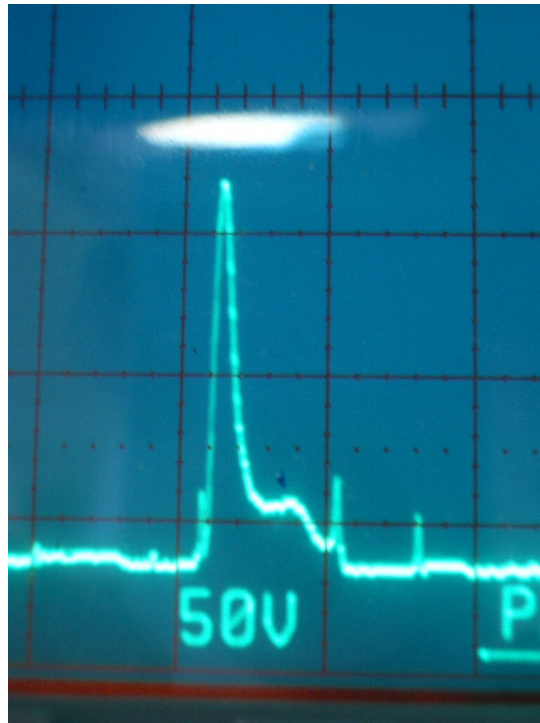

Fig. 29 (05.31.13:32) Details of a partial converted kick (on fig 27)

6.2 TESTS WITH 15" ECD

Batch #3	
Date	05.31.2007
Start time	2:02 PM
CC	3 CC all with secondary serie-connected.
Freq	1

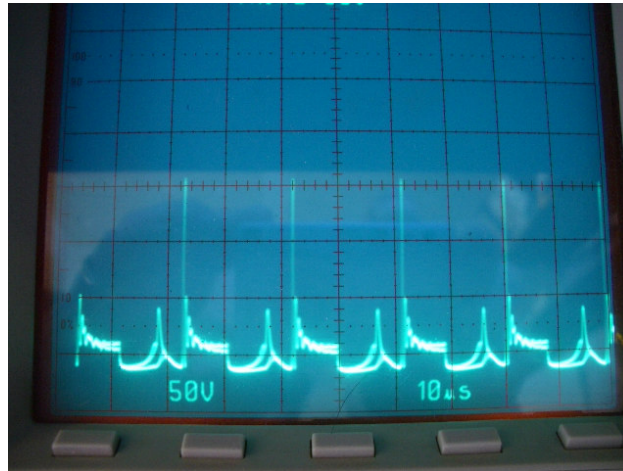

Fig. 30 16" ECD 3 CC and 1 Frequency

We see that with only one input frequency we have sine waves of about +50V. The sine waves appear just before any square wave, it means that with 16" ECD the sinus are created for every kick!

Here we noted another very interesting feature: as you vary the lowest freq, the Seed (as already said) slides to the right part of the baseline, does eat the kick and doing slowly this process you can see that as the sine wave is created in the same time the kick lessen.

Another interesting thing is that the light-bulb brightness is not in phase with the sine wave creation.

Batch #4	
Date	05.31.2007
Start time	1:35 PM
CC	1 only CC positioned at larger loop start.
Freq	1,2,3



Fig. 31 (05.31.2007 - 13:36) the Kick eater

In this case it is clear that the sine wave has eaten the second big Kick.

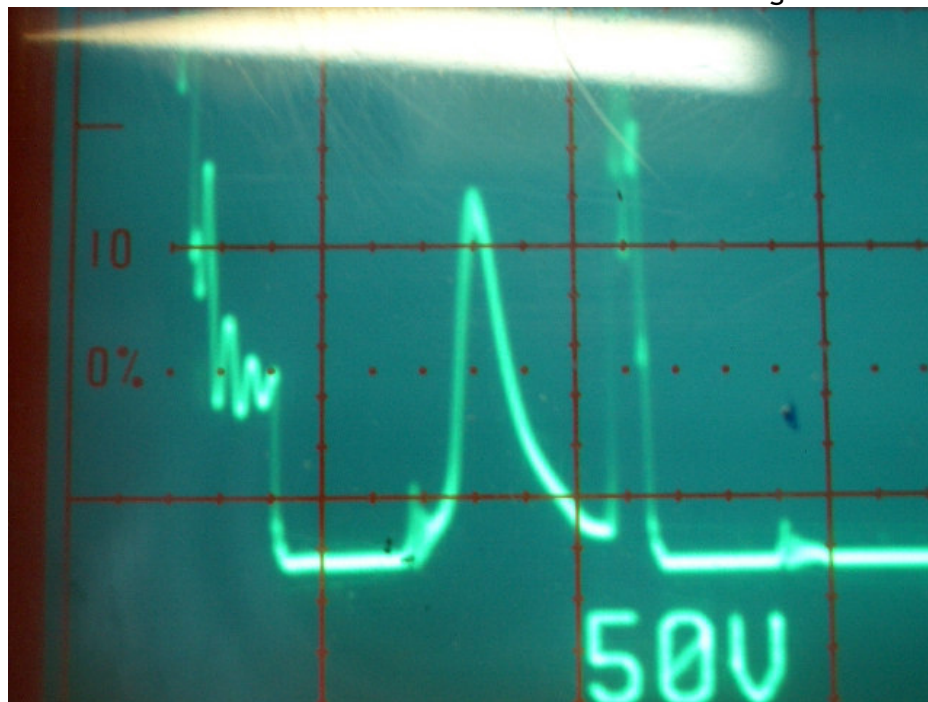

Fig. 32 (05.31.2007 - 13:38) Details of created sine wave (Seed on leading edge)

What it follows is a picture for waveforms taken on both lamp leads. The 0 scope level is on the screen center. You note that in this case there is no conversions as we are outside sweet point with the 3 freqs.

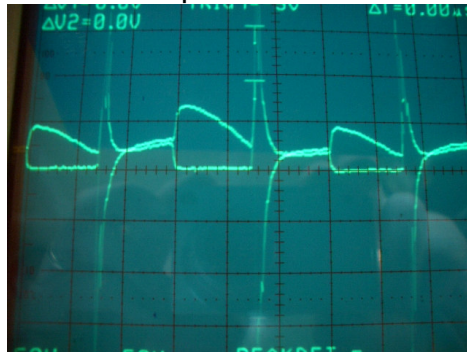

Fig. 33 (06.01.2007 - 14:27) Signals on load leads - no conversion

Like before but conversion processes are at their maximum, you can see large sine wave pieces well formed (on lower trace). It seems that the waveforms are now almost symmetrical as well.



Fig. 34 (06.01.2007 - 14:39) Signals on load leads - conversion @max

Please pay attention to the actual signals MIXING (0 level for lower trace on screen 2 main division over screen bottom; 0 level for upper trace is on screen center), the sine waves are all in positive region, the sum of both positive and negative peaks amount at about 1500-1600 VDC considering the 2 Mobius wires (a well high acceleration field!):

BREAKTROUGH

**WE DO HAVE SINE WAVE ON ONE LOAD LEAD (bottom pic)
AND DC PULSED ON THE OTHER LOAD LEAD (top pic) JUST
LIKE SAID BY SM**

And this using only **ONE COIL**.

Here is coming the sweet...just adj the freqs we do easily obtain more formed sine waves. The tuning process has been purposely kept slow to be sure **DO NOT OBTAIN A FULL CONVERSION**.

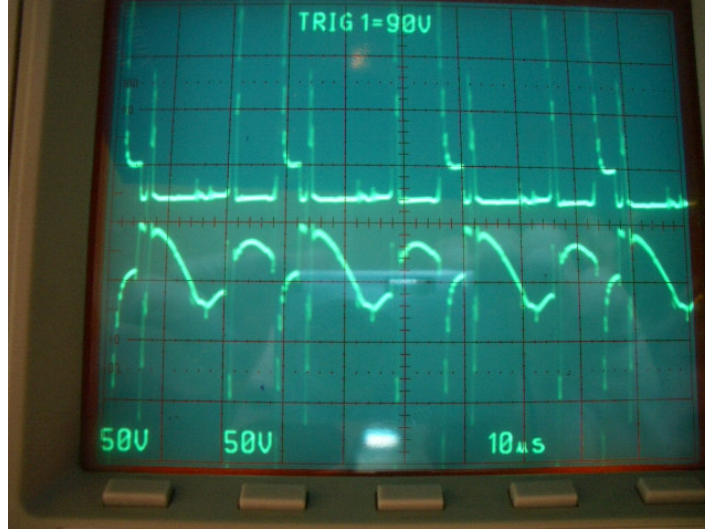

Fig. 35 (06.01.2007 - 15:47) More sine pieces fitting together

Most of sine waves on lower trace has been formed and we can see on PS a small voltage 'pumping'.

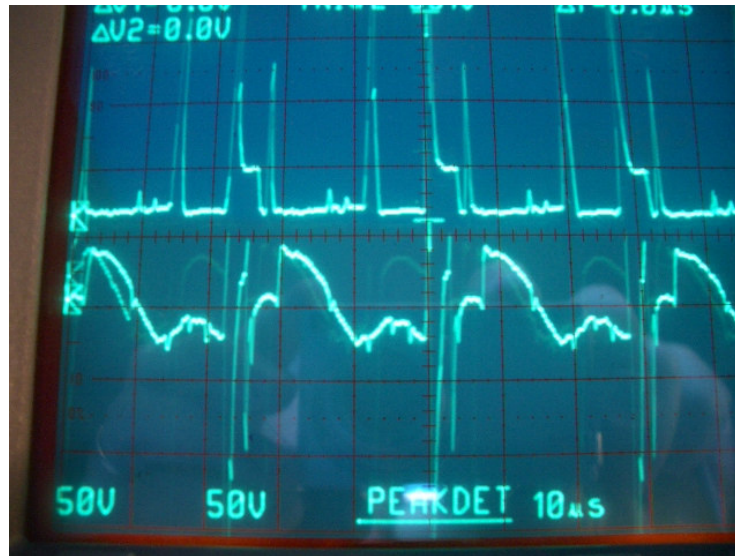

Fig. 36 (06.01.2007 - 15:42) Slow tuning in

Please do note that in fig 33 and 34 the zero level for lower trace is put at two screen main division over bottom line, so the sine wave is all in the first quadrant.

Unfortunately at this point my camera batteries went off and I forgot to bring the charger so I lost some of the latest picture shot to the 15" ECD. Anyway

Batch #5	
Date	05.31.2007
Start time	3:50 PM
CC	1 CC only (the 2 nd one).
Freq	1

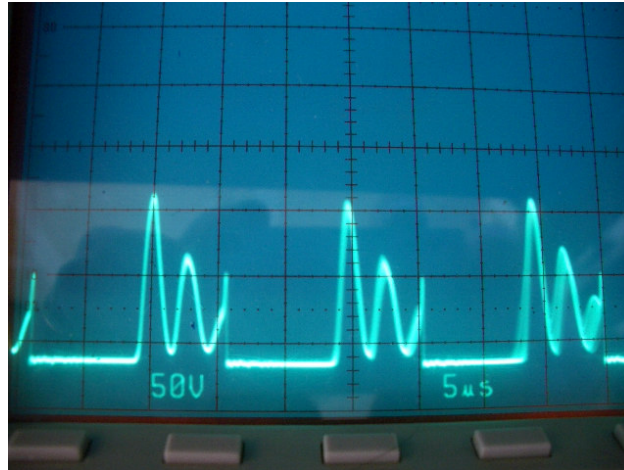

Fig. 37 16” ECD - 1 CC and 1 Frequency

It seems that using 2 Freqs is much more easy to quickly obtaining new ‘special kicks’. Pulsing only the second CC with only 1 freq = 66KHz we obtain pure but damped sine waves with an almost complete 2.5 cycles

Batch #6	
Date	05.31.2007
Start time	3:52 PM
CC	2 CC only. Secondary series connected
Freq	1, 2

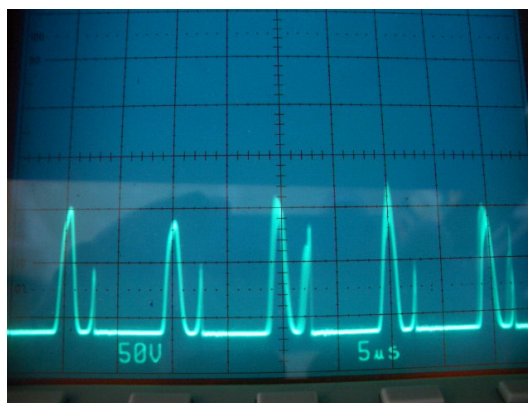

Fig. 38 (05.31.2007 - 15:52) 16” ECD - 2 CC and 2 Frequencies

With 2 frequencies we can get a pure sine wave of about 100V amplitude all in first quadrant (0 level is coincident with waveform base-line). Now we have to be very

careful as just refining a little the frequency it appears that the sine waves keep summing-up on top of the base square wave (freq F2 ranging from 10 -100KHz) as in next fig..

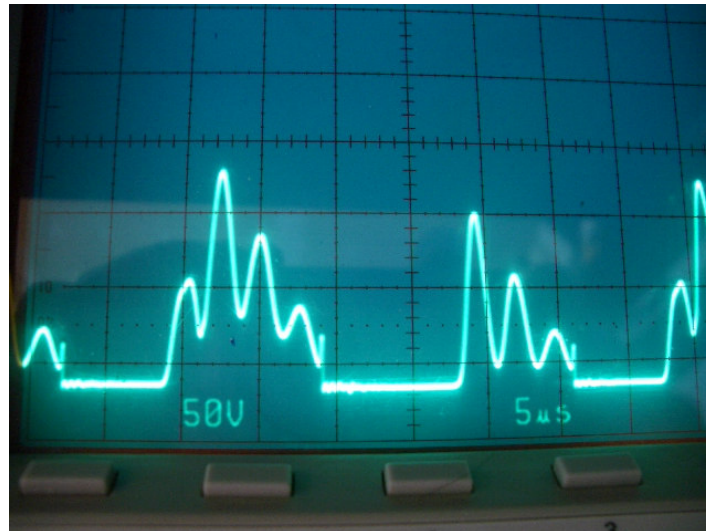

Fig. 39 (05.31.2007 - 16:05) 16" ECD - 2 CC and 2 Frequencies - 1 Sine waves summing on top

Continuing to refine frequencies

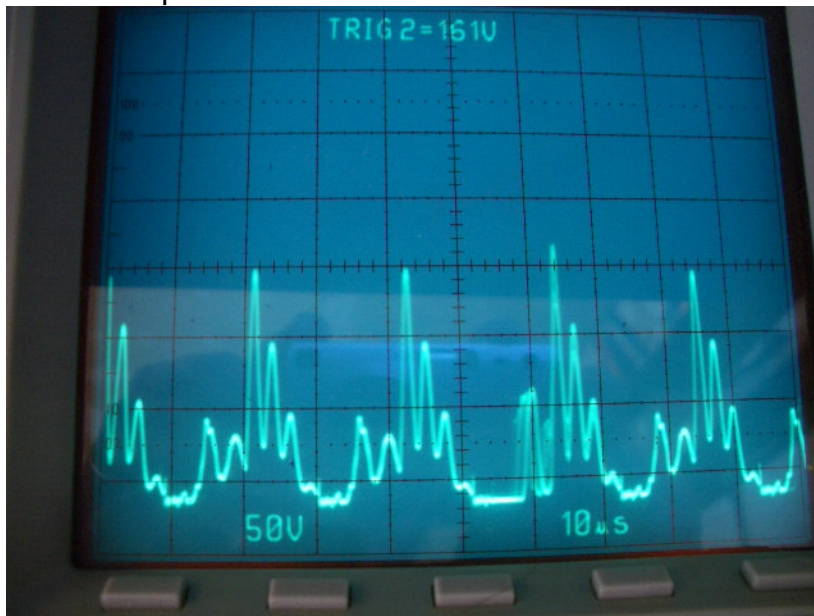

Fig. 40 (05.31.2007 - 16:04) 16" ECD - 2 CC and 2 Frequencies - 2 Sine waves summing on top

It is clear that we have now 2 waveforms forming:

1. The first sine wave is at F1 about 500 KHz.
2. The second sine wave is at F2 about 50 KHz.

The second freq is clearly distorted and for now mixed with the first.

Batch #7	
Date	06.02.2007
Start time	8:56 AM
CC	3 CC only. Secondary parallel connected
Freq	1, 2



Fig. 41 (06.02.2007 - 8:56) 16" ECD - 3 CC and 2 Frequencies - parallel connected -- almost full conversion

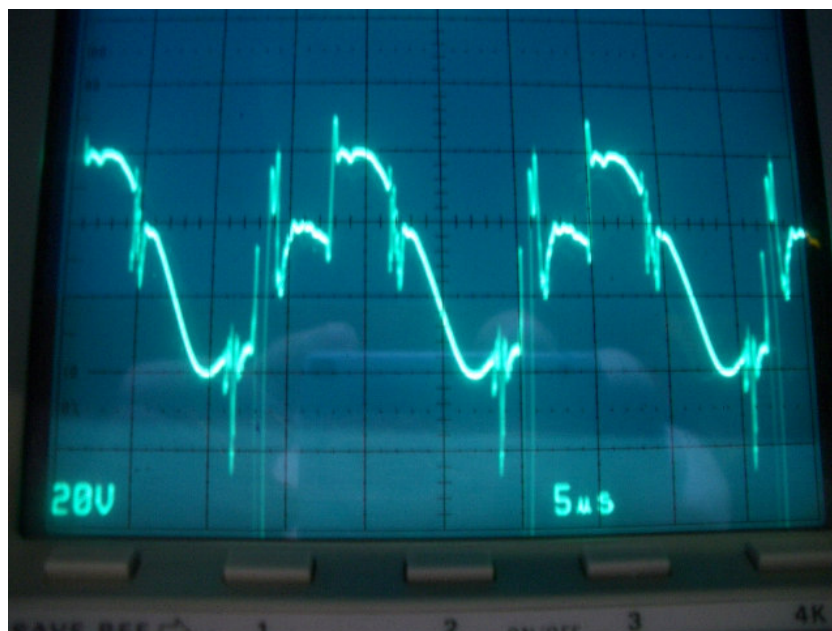

Fig. 42 (06.02.2007 - 15:53) 16" ECD - 3 CC and 2 Frequencies - parallel connected - almost full conversion

These two pictures are very important they do show an ALMOST COMPLETE CONVERSION, we accurately avoided to go-on in order to avoid possible damages.

The pictures has been taken with 3 input frequencies, 3 CC, a double Mobius loop and probe on load. The 0 level is set to the second screen line so the whole almost created sine wave at about 62 KHz is in first quadrant.

It is confirmed that for each complete piece of sinus there is the disappearing of one 'special kick'.

There is the confirmation of the 'turbine effect' as when firstly PS is switched-ON it is easy to see that the bulb-brightness does increase in a progressive way. The 100W/230V lamp does take about 2 sec to fully light-up, the 60W/230V does take about 3-4 sec.

Batch #8	
Date	05.31.2007
Start time	3:52 PM
CC	3 CC. Secondary parallel connected
Freq	1, 2, 3

Unfortunately the picture of this session has been lost but we noted that we could have kicks and sine waves totally independent!

7. SEED'S SHORT STUDY

As referenced many times in this document the key to open the Conversion process is what we have called 'The Seed'. This little artifact reaches actually about 40 V peak to peak and has an internal complex structure, generally it is possible to slide it along the time axis using the lowest freq oscillator. Here it follows what we have found.

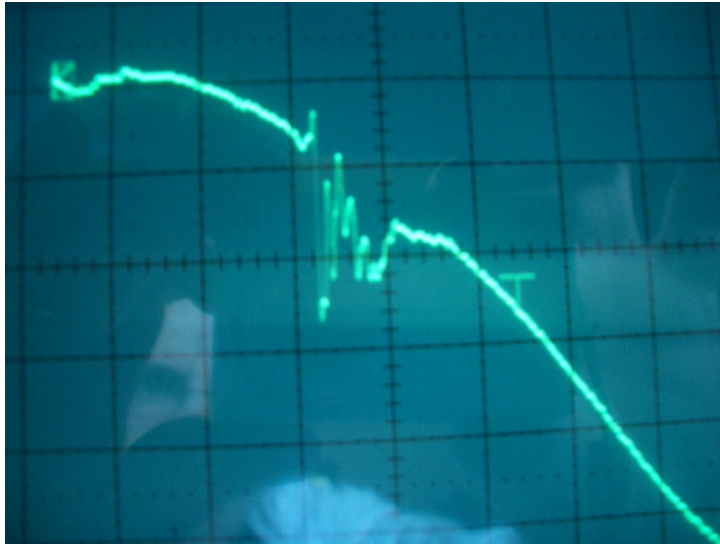

Fig. 43 The Seed (02.06.2007 - 16:09)

The Seed appears to be structured with a two mixed sine wave frequencies (Note: difficult to measure without errors):

- 1st about 2 MHz (+- 30% error?)
- 2nd about 6.6MHz (+- 30% error?)

First impressions is that they are just a mix of NMR signatures of Al and Cu (metals that happen to be near the ECD).

To prove that fact we bolted a block of Magnesium compound to 1 MOSFET's body and did the same test.

In fig 44 the result. There are two Seeds and several starting sinus. It appears that in this case there is only a single resonance showing 6 damped oscillations at a frequency of about 1 MHz and an amplitude of about 30V.

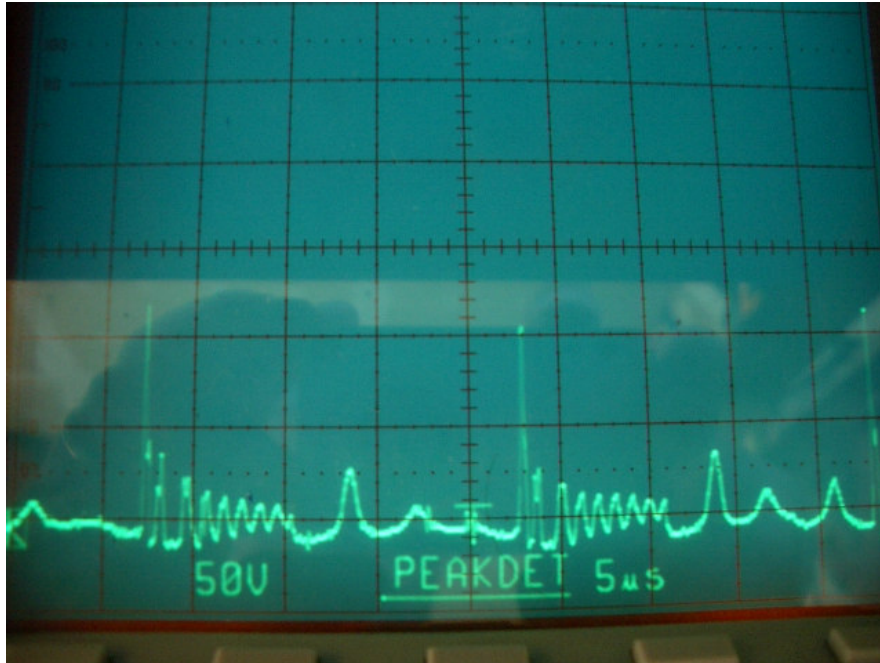

Fig. 44 (05.31.2007 - 15:39) Magnesium Seed Signature

BREAKTROUGH

To have Seeds the MOSFETS must be hot: they do have in this particular case to start the particles release job. This means that ECD must be allowed to reach an high temperature (but within their safe operating region) in order to show the effect. If temperature is less than a predetermined value (around 80 degrees centigrade) NO-WAY to obtain any Seed.

It happens that the Aluminum particles released by MOSFET's heat sink are actually released only when Aluminum is hot: that's a must. Please note that Aluminum can easily reach more that 100 °C well beyond the MOSFET's auto-shut-off protection feature.

Please note that the process may act like this: in the beginning is the MOSFET that heats his heat-sink, as the heat-sink reaches an higher temperature it starts immediately to release a stream of particles that get captured by the Mobius accelerator ring. This process is completely automatic, it does last about 2 -3 seconds. It can be seen just watching at the lamp filament brightness. There is a turbine like effect, actually you see that the filament start low red, than bright red, then steady shining white...all in 2 - 3 seconds.

BREAKTROUGH

As we cannot justify ourselves why the MOSFET did not went into auto shut-off region, we made this try: quickly we disconnected the MOSFET's body from his Aluminum heat-sink, we found that the MOSFET body where at a finger touchable

temperature (evaluated about 60 -70 °C) and the heat sink at an untouchable temperature, so much higher (an hand set at 15 cm over can feel an hot air flux) evaluated much more than 100 °C).

THIS IS CONTRARY OF ANY KNOWN THERMODYNAMICS LAWS.

Of course the two bodies must be at the same temperature as they were bolted together (or perhaps could be only a small temperature different gradient effect).

We think that the heat firstly supplied by the MOSFET triggered a positive feedback releasing in turn more and more particles till a certain point where an equilibrium was anyway reached. This process stresses a lot the internal Aluminum atomic structure hence producing the observed heat.

8. A SHORT FINAL CONSIDERATION

From the experience gained in all the tests it is clear that ECD is a sort of 'Annular Particles Accelerator' where as 'particles' we intend Electrons, Ions, etc. The particles are mainly released by all the near metals/alloys and also dielectric materials. The CC are the cannons.

The copper coils DC pulsing does provide:

1. magnetic field to accelerate particles,
2. 90 degree coupling to Mobius coil to capture the BEMF, RE,
3. additional energy on Mobius coil due to the NMR resonance effect.

You will find a well organized and commented paper here:

<http://magnetism.fateback.com/Overunity.htm>

The Mobius approach even with only a single 90 degree coil has been able to generate Seeds and so starting the peaks to sine waves conversion process.

The DC pulsed technique with 3 frequencies employed demonstrated good also to reconstruct the EM field necessary to deliver output power. It appears that each frequency has a special task like: initiate conversion, enhance power delivering, etc..

The ECD, when near conversion state is reached, does generate also a strong magnetic field, we checked it with a small magnet at meters of distance. This field does appear to extend, with a 20 degree inclination, toward the up position (this after moving up the 44 mm. 6" ring).

Till now it is not clear if the huge surge power experienced by Otto came from NMR resonance effect, ZPE tapping, earth energy tapping, etc.. In our opinion understanding the Seed is the key to obtain the peaks to sine waves conversion effect.