

# Magnets

permanent magnet materials



neodymium



ceramic



alnico

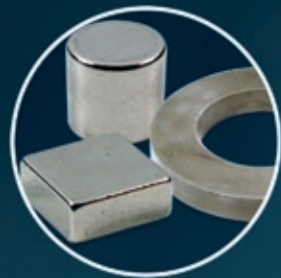

samarium cobalt

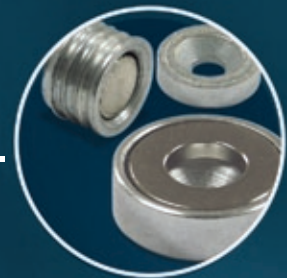

neodymium cups

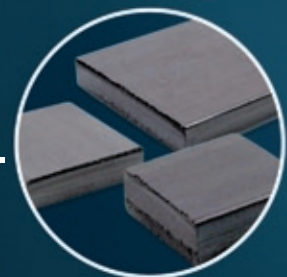

high energy



gaussmeters, etc.

# Request for Quote

An easy way to obtain a quote for your magnetic applications is to make a copy of this page, fill out as much information as possible and fax to 1.800.874.6248. You can also e-mail [pmm@magnetsource.com](mailto:pmm@magnetsource.com) for assistance. One of our customer service team members will contact you shortly.

Name \_\_\_\_\_  
Title/Position \_\_\_\_\_  
Company \_\_\_\_\_  
Address \_\_\_\_\_  
City \_\_\_\_\_  
State \_\_\_\_\_ Zip \_\_\_\_\_  
Country \_\_\_\_\_  
E-mail \_\_\_\_\_  
Phone \_\_\_\_\_  
Fax \_\_\_\_\_

## My Application:

Describe what you need the magnet to do:

\_\_\_\_\_  
\_\_\_\_\_  
\_\_\_\_\_  
\_\_\_\_\_  
\_\_\_\_\_  
\_\_\_\_\_  
\_\_\_\_\_  
\_\_\_\_\_  
\_\_\_\_\_  
\_\_\_\_\_  
\_\_\_\_\_  
\_\_\_\_\_  
\_\_\_\_\_  
\_\_\_\_\_  
\_\_\_\_\_  
\_\_\_\_\_  
\_\_\_\_\_  
\_\_\_\_\_  
\_\_\_\_\_  
\_\_\_\_\_  
\_\_\_\_\_

## Items I need a Quote for:

Please list part numbers of magnets needed from this catalog and quantities for each:

Part No.	Page	Quantity
_____	_____	_____
_____	_____	_____
_____	_____	_____
_____	_____	_____
_____	_____	_____
_____	_____	_____
_____	_____	_____
_____	_____	_____
_____	_____	_____

## Custom Magnet Requirements:

Material:  Neodymium  Ceramic  Alnico  
 Samarium Cobalt  High Energy

Size/Dimensions/Shape and Quantities:

\_\_\_\_\_  
\_\_\_\_\_  
\_\_\_\_\_  
\_\_\_\_\_  
\_\_\_\_\_  
\_\_\_\_\_

- Drawing attached
- I have e-mailed specifications to [pmm@magnetsource.com](mailto:pmm@magnetsource.com)
- Please have someone contact me

Fax Toll-free To 1.800.874.6248

# Contents

## Neodymium

Overview, Properties .....	4
Blocks, Rings .....	5
Discs .....	6
Custom Sizes, Surplus.....	7

## Ceramic

Overview, Properties .....	8
Discs .....	9
Blocks.....	10
Rings .....	11

## Alnico

Overview.....	12
Properties, Plugs, Rods.....	13
Horseshoes, Holding Magnets .....	14
Channel Horseshoes, Bars.....	15

## Samarium Cobalt

Overview, Properties .....	16
Rings, Blocks, Discs .....	17

## High Energy Flexible

Overview, Properties, High Energy Flexible Magnets.....	18
Flexible Magnet Pole Patterns .....	19

## Gaussmeters/Magnetizers/Pole Indicators .....

## Neodymium Magnetic Latches .....

## Magnetic Field Viewer/

## Glossary of Magnet Terminology .....

## Typical Magnetization Pole Patterns.....

---

## How to Choose the Right Magnet

**Application** - Describe to us how and for what purpose the magnet will be used (a mechanical drawing is extremely helpful). This will be the basis for all further questions and discussions.

**Shape** - Does your application require a specific shape of magnet? Most magnets are made in standard symmetrical shapes such as rings, discs, blocks, rods, and bars. Some types of magnets are machinable.

**Size** - Does your application require specific tolerances? Will the magnet be visible in your application? Our magnet tolerances are in accordance with International Magnetics Association/Magnet Materials Producers Association (IMA/MMPA) standards.

**Magnetization** - What does your application require? A magnet can be magnetized through the thickness, length, or even diameter depending on its orientation (see page 23). It can be magnetized with multiple poles – more than one pair of North/South poles – on one face of the magnet, or on both sides. Some magnets are limited in the ways they can be magnetized. The purpose for various magnetization patterns is to alter the magnet's strength to best fit an application.

**Quantity** - How many magnets do you need right now? How many magnets will you need over a year's time?

**Material** - Several types of magnet materials are available, including flexible (rubber) magnets, ceramic (strontium ferrite), alnico (Al Ni Co), samarium cobalt (Sm Co), and neodymium (Nd Fe B). Within each material group there are various grades. Each section in this catalog describes the characteristics and common applications of these materials. Most of these raw material magnets are used in OEM applications.

If your application calls for lifting, holding, retrieving, or separating ferrous metal items, then you may need a magnetic assembly (featured in our Magnetic Devices catalog). Magnetic assemblies are constructed from raw material magnets, which are combined with other components to meet a specific application.

**Strength** - The application will determine the strength of the magnet you need. Raw material magnets are rated by megagauss oersteds, or more commonly, gauss. For this information, please consult the table of characteristics in the introduction of each magnetic material.

Magnetic assemblies, in contrast, are usually rated by pounds of pull.

# Neodymium Magnets

(Super Magnets)

Neodymium Iron Boron (Nd-Fe-B) or Neodymium magnets are extremely strong for their size. Shapes include rings, blocks, discs and custom. To prevent unwanted oxidation, neodymium magnets are usually finished with a zinc, nickel or epoxy coating.

**Manufacturing** - In general, the elements are melted together and milled into a powder that is dry-pressed to shape in the presence of a magnetic field.

The material is then sintered, ground to dimension, magnetized and tested. They are called "rare earth" magnets because the elements of neodymium are classified as such in the lanthanides section of the Periodic Table of the Elements.

## Attributes of Neodymium

- Very high resistance to demagnetization
- High magnetic energy for size
- Good in ambient temperature
- Material is corrosive and should be plated for long term maximum energy output
- Low working temperature for heat applications

**Tolerances** - For as-pressed material, tolerance on the thickness (direction of magnetization) is  $\pm .005"$ . Other dimensions are  $\pm 2.5%$  or  $\pm .005"$ , whichever is greater.

According to International Magnetics Association/Magnet Materials Producers Association (IMA/MMPA) standards, visual imperfections such as hairline cracks, porosity and minor chips are commonly found in sintered magnets. A chipped edge is considered acceptable if no more than 10%

of the surface is missing. Cracks are acceptable as long as they do not extend across more than 50% of the pole's surface.

**Applications of Neodymium** - Ideal for applications where a very high magnetic force is needed in a small area. Medical equipment, magnetic separators, linear actuators, microphone assemblies, servo motors, DC motors (automotive starters), computer rigid disc drives, printers and speakers are a few examples.

**Magnetizing and Handling** - Neodymium magnets are very brittle and very strong magnetically. Therefore, it is crucial to handle these magnets with extreme care to avoid personal injury and damage to the magnets. Fingers can be severely pinched between attracting magnets. Magnets can chip if allowed to "jump at" an attracting object. It is highly recommended that when constructing rare earth magnetic assemblies, they be magnetized after assembly.

**Machining** - Since neodymium magnet material is prone to chipping and cracking, it does not lend itself to conventional machining methods. It can, however, be abrasively ground, but only with the use of liberal amounts of coolant. The coolant minimizes heat fracturing and the risk of fires caused by oxidized grinding dust.

## Typical Magnetic and Physical Properties of Neodymium Magnet Material

Neodymium Material	Density		Max. Energy Product BH(max) MGO	Residual Induction Br Gauss	Coercive Force Hc Oersteds	Intrinsic Coercive Force (Hci) Oersteds	Maximum Operating Temperature		Curie Temperature	
	lbs/in <sup>3</sup>	g/cm <sup>3</sup>					F°	C°	F°	C°
<b>Neodymium 27SH</b>	0.267	7.4	27.0	10800	9800	20000	302	150	572	300
<b>Neodymium 30H</b>	0.267	7.4	30.0	11000	10500	17000	212	100	572	300
<b>Neodymium 35</b>	0.267	7.4	35.0	12300	10500	$\geq 12000$	176	80	536	280
<b>Neodymium 40</b>	0.267	7.4	40.0	12900	10500	$\geq 12000$	176	80	536	280
<b>Neodymium 45</b>	0.267	7.4	45.0	13500	11000	$\geq 12000$	176	80	536	280

Since many combinations of elements and orientations are possible, additional grades are available.

# Neodymium Blocks

Part No.	Dimensions in Inches			Approx. Weight (Lbs.)	Grade in MGO
	Thickness	Width	Length		
NB045-35	0.045	0.101	0.200	0.0002	35
NB0781547N-35	0.074	0.153	0.467	0.0014	35
NB11325N-35	0.100	0.130	0.250	0.0008	35
NB12525N-35	0.100	0.250	0.250	0.0016	35
NB001004N	0.100	0.500	0.500	0.0067	35
NB15321N-35	0.150	0.320	1.000	0.0128	35
NB188S375N-35	0.188	0.188	0.375	0.0354	35
NB30N-35	0.230	0.230	0.750	0.0106	35
NB239646-30	0.234	0.391	0.469	0.0115	30
NB25575N-30	0.250	0.500	0.750	0.0250	30
NB25575N-35	0.250	0.500	0.750	0.0250	35
NB502575-30	0.500	0.250	0.750	0.0250	30
NB50502N-35	0.500	0.500	2.000	0.1340	35
NB006N-35	0.500	1.000	1.000	0.1340	35
NB058N-35MAG	0.500	2.000	2.000	0.5340	35
NB147N-35MAG	1.000	2.000	2.000	1.0680	35

**NOTE:** A second "N" in the part number indicates nickel plating. Other sizes and grades may be available. All dimensions approximate.

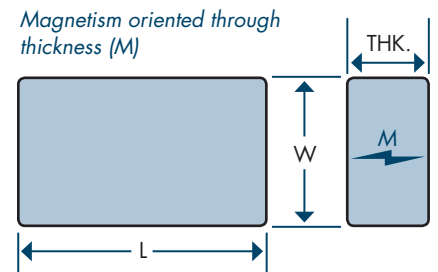
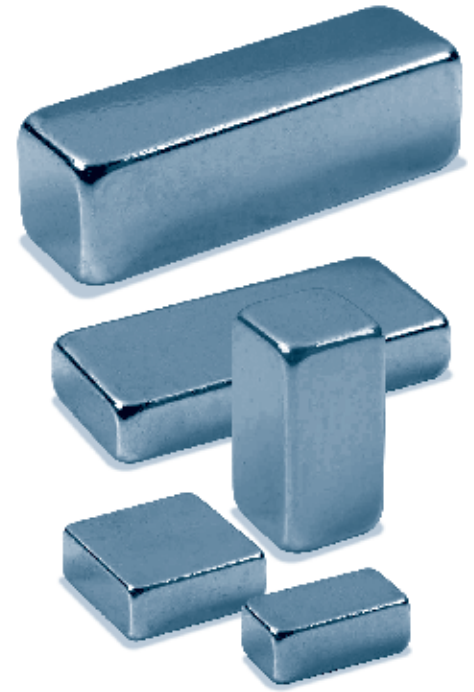

# Neodymium Rings

Part No.	Dimensions in Inches			Approx. Weight (Lbs.)	Grade in MGO
	Outer Dia.	Inner Dia.	Thickness		
NR152N-35	0.375	0.125	0.060	0.00157	35
NR004705N	0.472	0.250	0.374	0.01258	35
NR005400NH	0.540	0.270	0.325	0.01500	30
NR007403N	0.740	0.375	0.105	0.00880	35
NR741N-30	0.745	0.450	0.100	0.00739	30
NR010007N	1.000	0.500	0.110	0.01710	35

**NOTE:** A second "N" in the part number indicates nickel plating. All dimensions are approximate. Other sizes and grades may be available.

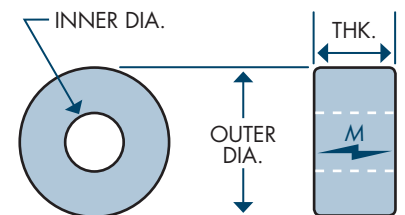

Magnetism oriented through thickness (M)

# Neodymium Discs

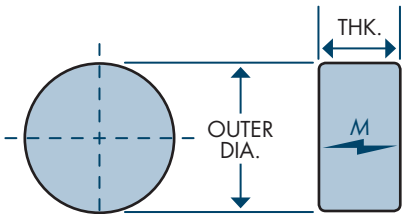

Magnetism oriented through thickness (M)

**NOTE:** A second "N" in the part number indicates nickel plating.

**Tolerances:** ± .005 on diameter, + .005 on thickness.

All dimensions approximate.

## Custom sizes available.

Call us with your grade, dimension and tolerance requirements.

Part No.	Dimensions in Inches		Approx. Weight (Lbs.)	Grade in MGO
	Diameter	Thickness		
ND001209N	0.125	0.125	0.00050	35
ND12525N-35	0.125	0.250	0.00082	35
ND18703-35	0.187	0.030	0.00030	35
ND18703N-35	0.187	0.030	0.00030	35
ND308N-35	0.187	0.060	0.00044	35
ND18725N-35	0.187	0.250	0.00184	35
ND022N-35	0.197	0.059	0.00048	35
ND002507N	0.250	0.080	0.00110	35
ND146N-35	0.250	0.100	0.00131	35
ND145N-35	0.250	0.200	0.00262	35
ND283N-35	0.250	0.250	0.00328	35
ND002511N	0.250	0.375	0.00490	35
ND255N-35	0.250	0.500	0.00650	35
ND003106N	0.315	0.118	0.00240	35
ND003602N	0.360	0.075	0.00200	35
ND060N-35	0.375	0.100	0.00296	35
ND187N-35	0.375	0.250	0.00740	35
ND2012N-35	0.375	0.375	0.01106	35
ND381N-35	0.375	1.000	0.02949	35
ND004700N	0.472	0.118	0.00540	35
ND004903N	0.490	0.105	0.00520	35
ND103N-35	0.500	0.125	0.00655	35
ND140N-35	0.500	0.200	0.01052	35
ND143N-35	0.500	0.250	0.01320	35
ND151N-35	0.500	0.500	0.02621	35

# Neodymium Discs

Part No.	Dimensions in Inches		Approx. Weight (Lbs.)	Grade in MGO
	Diameter	Thickness		
ND007000N	0.709	0.118	0.01230	35
ND6006N-35	0.750	0.100	0.01181	35
ND007509N	0.750	0.125	0.01480	35
ND064N-35	0.750	0.187	0.02211	35
ND142N-35	0.750	0.375	0.04423	35
ND008704N	0.875	0.375	0.06020	35
ND008706N	0.875	0.450	0.07220	35
ND048N-35	0.875	1.000	0.16055	35
ND010003N	1.000	0.125	0.02620	35
ND105N-35	1.000	0.187	0.03921	35
ND125N-35	1.000	0.250	0.05243	35
ND150N-35	1.000	0.375	0.07864	35
ND025N-35	1.000	0.500	0.10510	35
ND030N-35	1.000	0.750	0.15738	35

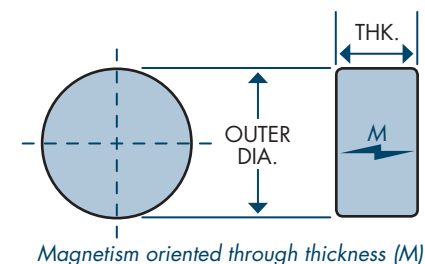

## Custom Neodymium Magnets

If the neodymium magnet you require is not listed on these pages, we may be able to create custom sizes and specifications for you. Please contact us and provide the shape, dimensions, tolerance, and grade of neodymium needed.

Minimum quantities are required. To begin your order, please call one of our magnet specialists toll-free at **1.888.293.9399**, fax your request and drawing toll-free to **1.800.874.6248**, or e-mail us at **pmm@magnetsource.com**.



Images for shape illustration – not to scale.

# Ceramic Magnets

Ceramic (ferrite) magnets are composed of strontium carbonate and iron oxide. They are charcoal gray in color and usually appear in the forms of discs, rings, blocks, cylinders, and sometimes arcs for motors.

**Manufacturing** - A powdered mixture of strontium carbonate and iron oxide is injected into a wet or dry press for forming. During this process, a magnetic field is applied in the direction of preferred magnetization to orient the material and increase the magnet's performance potential. This magnet is considered "oriented" (anisotropic). If not exposed to a magnetic field at time of formation, it is called "non-oriented" (isotropic).

After the molding process, the material is then sintered at about 2000°F. This process is similar to that of kilning ceramic pottery, thus the popular name "ceramic" magnet.

Lastly, the magnet is finish-ground to size with a diamond-bladed grinding wheel, magnetized, and inspected for shipment.

## Attributes of Ceramic Magnets

- High intrinsic coercive force
- Limited to simple shapes
- Service temperature greater than rare earth and lower than alnico
- Finishing requires diamond cutting or grinding wheel
- Energy product lower than alnico and rare earth magnets
- Most common grades are 1, 5 and 8
- Grade 8 is the strongest ceramic available

## Applications of Ceramic Magnets

- Speaker magnets
- DC brushless motors
- Magnetic Resonance Imaging (MRI)
- Magnetos used on lawn mowers, outboard motors

- DC permanent magnet motors (used in cars)
- Separators (ferrous material from non-ferrous)
- Used in magnetic assemblies designed for lifting, holding, retrieving and separating

**Tolerances** - Pressed dimensions are either  $\pm 2\%$  or  $\pm .025"$ , whichever is greater. Cut dimensions are either  $\pm 3\%$  or  $\pm .025"$ , whichever is greater. Thickness tolerances are normally ground to  $\pm .005"$ , according to International Magnetics Association/Magnet Materials Producers Association (IMA/MMPA).

Visual imperfections such as cracks, porosity, voids, surface finish, etc. (commonly found in sintered ceramic magnets) do not constitute cause for rejection. Chips are acceptable if no more than 5% of the pole surface is removed. Cracks are acceptable, provided they do not extend across more than 50% of the pole surface.

**Magnetizing and Handling** - Ceramic magnet material is extremely brittle and can chip or break if dropped on a hard surface, or if allowed to "jump at" an attracting object.

The weakest grade of ceramic material is grade 1, which is typically non-oriented. Grades 5 and 8 are oriented ceramic material. When making magnetic assemblies with ceramic, it is typically easier to magnetize the product after assembly.

**Machining** - Since ceramic material is so brittle, it requires special machining techniques and equipment. We can cut and grind ceramic material to your specifications. However, lead times vary.

## Typical Magnetic and Physical Properties of Ceramic Magnet Material

Ceramic Material	Density		Max. Energy Product BH(max)	Residual Induction Br	Coercive Force Hc	Intrinsic Coercive Force (Hci)	Maximum Operating Temperature		Curie Temperature	
	lbs/in <sup>3</sup>	g/cm <sup>3</sup>	MGO	Gauss	Oersteds	Oersteds	F°	C°	F°	C°
<b>Ceramic 1</b>	0.177	4.9	1.05	2300	1860	3250	400	204	842	450
<b>Ceramic 5</b>	0.177	4.9	3.4	3800	2400	2500	400	204	842	450
<b>Ceramic 8</b>	0.177	4.9	3.5	3850	2950	3050	400	204	842	450

**Note:** Unshielded open circuit ceramic magnets should not be subjected to more than 400°F or they will require remagnetization.



# Ceramic Discs

Part No.	Dimensions in Inches		Approx. Weight (Lbs.)	Grade
	Diameter	Thickness		
CD06	0.187	0.187	0.0008	1
CD002500C	0.250	0.281	0.0025	5
CD312N	0.312	0.125	0.0017	5
CD003500	0.350	0.250	0.0043	5
CD02	0.375	0.125	0.0024	1
CD0225N	0.375	0.250	0.0046	1
CD12C	0.375	0.410	0.0079	5
CD13C	0.460	0.400	0.0116	5
CD14N	0.472	0.197	0.0060	8
CD04	0.492	0.187	0.0062	1
CD004904	0.496	0.138	0.0048	5
CD031N	0.500	0.100	0.0034	5
CD15	0.500	0.180	0.0062	5
CD005000	0.500	0.230	0.0081	5
CD6212	0.562	0.125	0.0056	5
CD0625	0.625	0.125	0.0064	1
CD0625/2P	0.625	0.125	0.0064	1
CD25J	0.625	0.375	0.0201	5
CD10N	0.701	0.197	0.0137	8
CD10J	0.709	0.197	0.0136	5
CD710N	0.710	0.250	0.0173	5
CD07N	0.750	0.250	0.0193	1
CD007500	0.750	0.375	0.0298	8
CD9C	0.787	0.156	0.0133	5
CD20NMAG	0.866	1.000	0.1052	8
CD0875MP	0.875	0.120	0.0121	1
CD970N	0.970	0.156	0.0202	8
CD970MPN	0.970	0.156	0.0202	5,MP
CD985MPN	0.985	0.200	0.0267	1,MP
CD010000MAG	1.000	0.625	0.0884	5
CD010002	1.000	0.250	0.0353	5
CD150N	1.500	0.187	0.0580	1,MP

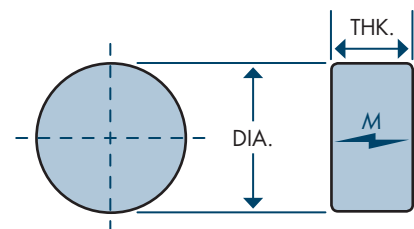

Magnetism oriented through thickness (M)

**Key:** **1** = Grade 1 ceramic  
**5** = Grade 5 ceramic  
**8** = Grade 8 ceramic (strongest ceramic material available)  
**MP** = Multiple poles on surface.  
 All dimensions approximate.

**Other sizes are available.**

Call us with your grade, dimension and tolerance requirements.

# Ceramic Blocks

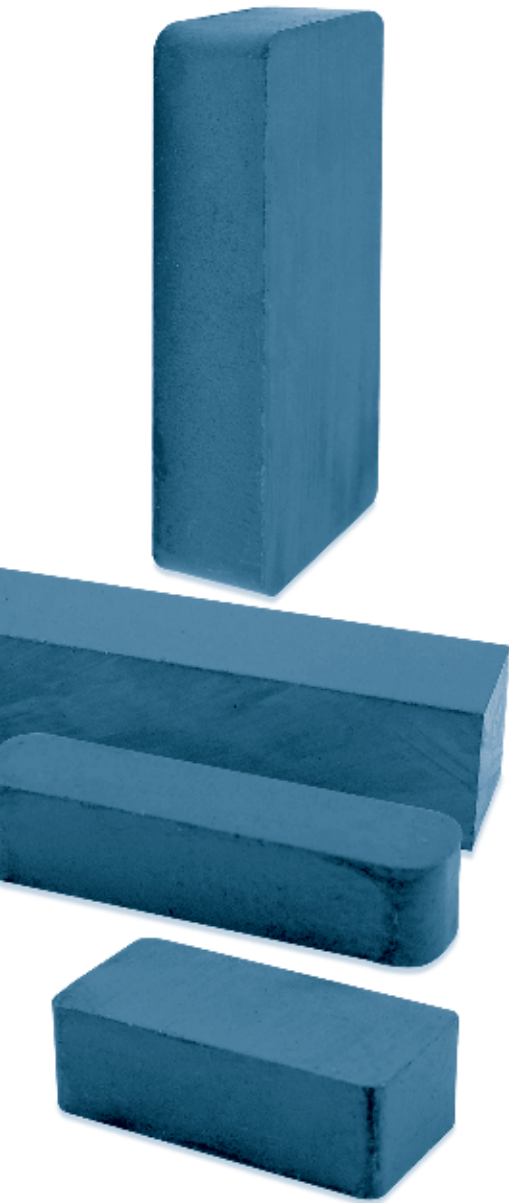

Magnetism oriented through thickness (M)

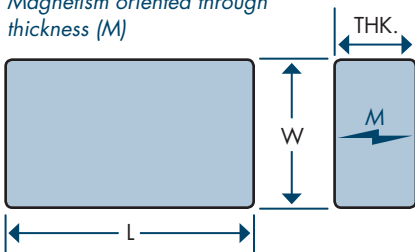

- Key:** 1 = Grade 1 ceramic  
 5 = Grade 5 ceramic  
 8 = Grade 8 ceramic (strongest ceramic material available)  
 H0 = .197" hole  
 H1 = has a .1875" hole through the middle  
 2H = has 2 holes 3/16" dia., 1" center to center. All dimensions approximate.

Part No.	Dimensions in Inches			Approx. Weight (Lbs.)	Grade
	Thickness	Width	Length		
CB001209	0.125	0.109	0.375	0.0009	5
CB3N	0.197	0.227	0.874	0.0070	5
CB41STC	0.187	0.750	1.000	0.0250	5, H1
CB41IPC	0.197	0.750	0.984	0.0248	5, H0
CB40C	0.197	0.750	1.000	0.0250	1, H0
CB002001	0.200	0.375	0.750	0.0101	8
CB29MAG	0.214	0.750	2.500	0.0700	5
CB002200	0.224	0.250	2.240	0.0226	8
CB2301	0.230	0.230	1.000	0.0093	5
CB1435	0.236	0.354	1.180	0.0170	5
CB246N	0.240	0.622	1.960	0.0510	5
CB247MAG	0.240	0.755	1.960	0.0650	5
CB31MAG	0.250	0.250	3.000	0.0330	5
CB1434N	0.250	0.375	0.750	0.0120	5
CB14342N	0.250	0.375	1.500	0.0250	5
CB257MAG	0.250	0.750	0.750	0.0246	5
CB219NMAG	0.250	2.000	3.000	0.2630	5
CB124	0.250	0.500	1.000	0.0210	1
CB60NMAG	0.393	0.875	1.875	0.1128	5
CB60N	0.393	0.875	1.875	0.1128	5
CB60-2P	0.393	0.875	1.875	0.1128	5
CB003907MAG	0.393	0.875	0.925	0.0573	5
CB65MAG	0.393	0.400	1.875	0.0460	5
CB60/2HMAG	0.393	0.875	1.875	0.0980	5,2H
CB702NMAG	0.500	1.000	2.000	0.1750	5
CB70NMAG	0.500	1.000	6.000	0.5250	5
CB802NMAG	0.500	2.000	3.000	0.5250	5,8
CB005033	0.500	2.000	6.000	1.0500	8
CB85MAG	0.500	4.000	6.000	2.1000	8
CB95MAG	0.750	4.000	6.000	3.1500	5
CB187MAG	1.000	1.000	6.000	1.0500	8
CB1862NMAG	1.000	2.000	2.000	0.7000	5
CB1863NMAG	1.000	2.000	3.000	1.0500	5
CB186NMAG	1.000	2.000	6.000	2.1000	5
CB188NMAG	1.000	3.000	4.000	2.1000	5
CB185CMAG	1.000	4.000	6.000	4.2000	8

**Other sizes are available.**

Call us with your grade, dimension and tolerance requirements.

# Ceramic Rings

Part No.	Dimensions in Inches			Approx. Weight (Lbs.)	Grade
	Outer Dia.	Inner Dia.	Thickness		
CR552282	0.550	0.228	0.200	0.0071	5
CR551209078	0.551	0.197	0.078	0.0029	8
CR551209098	0.551	0.197	0.098	0.0037	8
CR10N	0.689	0.296	0.118	0.0065	8
CR74RMXC	0.745	0.250	0.392	0.0270	5
CR75	0.750	0.250	0.250	0.0170	1
CR75N	0.750	0.250	0.250	0.0170	1
CR106	1.060	0.216	0.125	0.0190	1
CR120	1.125	0.750	0.125	0.0120	1
CR119811	1.181	0.983	0.115	0.0065	1
CR012300	1.235	0.374	0.182	0.0356	5
CR145N	1.250	0.375	0.187	0.0370	5
CR154	1.550	0.882	0.224	0.0514	5
CR175MAG	1.750	0.865	0.225	0.0710	5
CR162	1.750	1.280	0.250	0.0467	1
CR45	1.770	0.866	0.314	0.1030	5
CR021900MAG	2.198	0.469	0.495	0.3230	8
CR250NMAG	2.360	1.140	0.331	0.1998	5
CR238128MAG	2.380	1.000	0.280	0.1850	5
CR280MAG	2.800	1.203	0.330	0.2900	5
CR337AMAG	3.376	1.280	0.425	0.5700	5
CR337CMAG	3.376	1.280	0.850	1.1400	5
CR039401	3.940	1.970	0.322	0.5300	5
CR454AMAG	4.540	1.750	0.400	0.9650	5
CR525NMAG	5.270	2.210	0.550	1.8110	5
CR525CNMAG	5.275	2.240	0.750	2.2900	5
CR700RCMAG	7.500	3.250	0.750	4.7100	5

**Key:** 1 = Grade 1 ceramic 5 = Grade 5 ceramic  
 8 = Grade 8 ceramic (strongest ceramic material available)  
 All dimensions approximate.

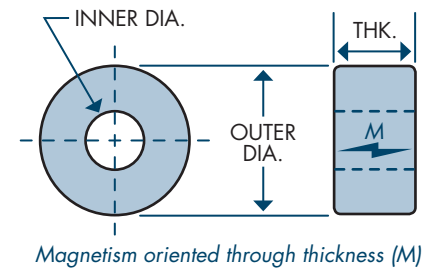
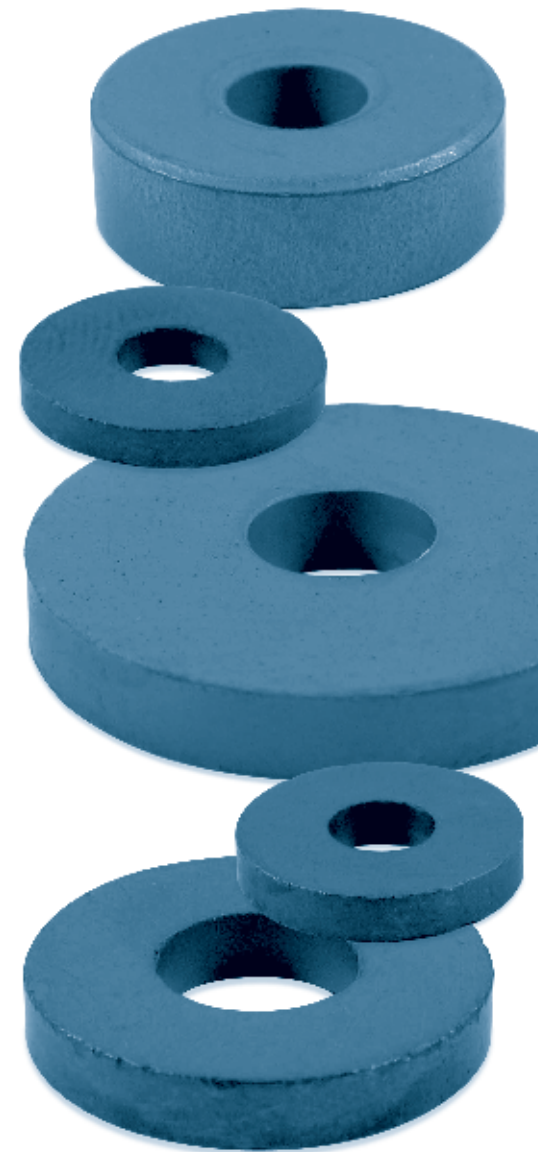

**Other sizes are available.**  
 Call us with your grade, dimension and tolerance requirements.

# Alnico Magnets

Alnico magnets are made primarily from aluminum, nickel, cobalt, copper, iron and sometimes titanium. Alnico alloys are formed by casting process or are sintered.

**Cast Alnico** - Cast alnico is melted and poured into a mold. Once solidified, the material is rough ground, then heat-treated and cooled, sometimes within a magnetic field. When treated in the presence of a magnetic field, the magnet is called anisotropic (oriented). This orients the material to take on maximum magnetization and allows a higher gauss level. A cast magnet that is not heat-treated in a magnetic field is called isotropic (non-oriented). After heat treatment and cooling, alnico can be ground to specific tolerances, then magnetized.

## Attributes of Cast Alnico

- Size parameters range from 1 oz. to about 70 lbs. (0.25" dia. x 0.50" and larger)
- Easily casted to a variety of shapes and sizes

**Sintered Alnico** - Sintered alnico is made from a powdered mixture of ingredients that are pressed into a die under tons of pressure, sintered in a hydrogen atmosphere and then cooled either within or without a magnetic field (anisotropic vs. isotropic).

## Attributes of Sintered Alnico

- Size parameters range from about 1 oz. to 1 cubic inch of material (0.25" dia. x 0.50" and larger)
- Can be pressed to close tolerances requiring only minimal grinding to finish
- Mechanically strongest of alnicos

## Attributes of Both Cast and Sintered Alnico

- Very temperature stable, great for high heat applications
- Maximum working temperature 975° - 1020° F
- May be ground to size
- Does not lend itself to conventional machining (hard and brittle)
- High residual induction and energy product compared to ceramic material

- Low coercive force compared to ceramic and rare earth materials (more subject to demagnetization)
- Most common grades of alnico are 5 and 8
- Not suited for repelling or high friction applications

**Applications of Alnico Magnets** - Separators, sensors, electron tubes, traveling wave tubes, radar, holding magnets, coin acceptors, clutches and bearings, auto ignition magnetos, motors, distributors, relays, controls, generators, receivers, telephones, bell ringers, microphones, guitar pickups, loudspeakers, security systems, cow magnets.

**Tolerances** - Unless otherwise specified, our tolerances on alnico material meet and often exceed International Magnetism Association/Magnet Materials Producers Association (IMA/MMPA) standards.

For unfinished surfaces (as cast) the following tolerances apply:

0-1" ± .016"	1-3" ± .031"	3-5 ± .047"
5-7" ± .062"	7-9" ± .078"	9-12" ± .094"

Finished surfaces are normally ground to ± .005".

**Magnetizing and Handling** - Magnetizing is done after the magnet has been machined to the correct tolerances. Care should be taken when handling alnico material since it is brittle and can chip or break if dropped on a hard surface. Also, because it has a low resistance to demagnetization, it will lose power if it is stored improperly (poles repelling each other). For best results, store magnetized alnico so that pieces are attracting each other, or with a steel keeper.

**Machining** - Alnico is a very hard and brittle material and does not lend itself to conventional machining. The Magnet Source™ employs experienced machinists and the proper equipment to grind alnico to its required dimensions.

## Typical Magnetic and Physical Properties of Alnico Magnet Material

Alnico Material	Density		Max. Energy Product BH(max)	Residual Induction Br	Coercive Force Hc	Intrinsic Coercive Force (Hci)	Maximum Operating Temperature		Curie Temperature	
	lbs/in <sup>3</sup>	g/cm <sup>3</sup>	MGO	Gauss	Oersteds	Oersteds	F°	C°	F°	C°
	<b>Alnico 5 (cast)</b>	0.264	7.3	5.5	12800	640	640	975	525	1580
<b>Alnico 8 (cast)</b>	0.262	7.3	5.3	8200	1650	1860	1020	550	1580	860
<b>Alnico 5 (sintered)</b>	0.250	6.9	3.9	10900	620	630	975	525	1580	860
<b>Alnico 8 (sintered)</b>	0.252	7.0	4.0	7400	1500	1690	1020	550	1580	860

## Alnico 5 Plugs

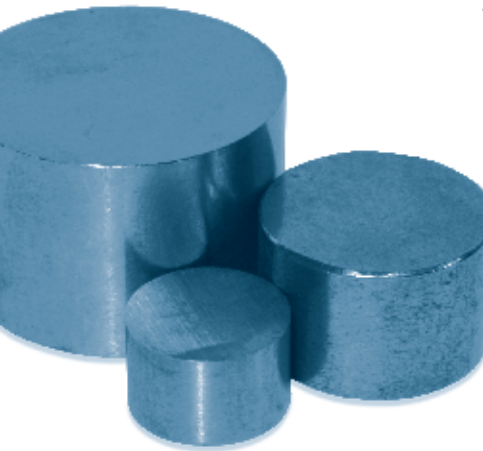

Part No.	Dimensions in Inches		Approx. Weight (Lbs.)
	Diameter	Thickness	
<b>10001</b>	0.689	0.430	0.043
<b>10002</b>	0.759	0.522	0.063
<b>10003</b>	0.840	0.626	0.092
<b>10004</b>	0.908	0.535	0.092
<b>10005</b>	1.114	0.765	0.198
<b>10006</b>	1.151	0.970	0.425

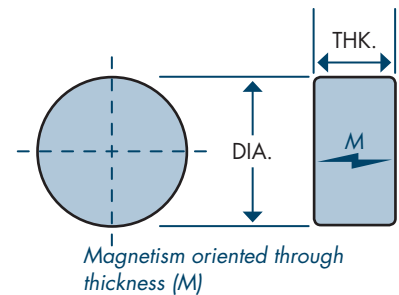

Tolerances: ± .005 on all dimensions. All dimensions approximate.

**Other sizes are available.**

Call us with your grade, dimension and tolerance requirements.

## Alnico 5 Rods

Diameter	Length in Inches														Weight (Lbs./inch)	
	3/8	1/2	5/8	3/4	1	1-1/4	1-1/2	1-3/4	2	3	4	5	6	8		
<b>1/8</b>	•	•	•	•	•	•	•	•	•	•	•	•	•	•	—	0.0033
<b>3/16</b>	•	•	•	•	•	•	•	•	•	•	•	•	•	•	—	0.0074
<b>1/4</b>	•	•	•	•	•	•	•	•	•	•	•	•	•	•	•	0.0135
<b>5/16</b>	—	•	—	•	•	•	•	•	•	•	•	•	•	•	•	0.0202
<b>3/8</b>	—	•	—	•	•	•	•	•	•	•	•	•	•	•	•	0.0305
<b>1/2</b>	—	•	—	•	•	•	•	•	•	•	•	•	•	•	•	0.0520
<b>7/8</b>	—	—	—	—	•	•	•	•	•	•	•	•	•	•	•	0.1587
<b>1</b>	—	—	—	—	•	•	•	•	•	•	•	•	•	•	•	0.2073

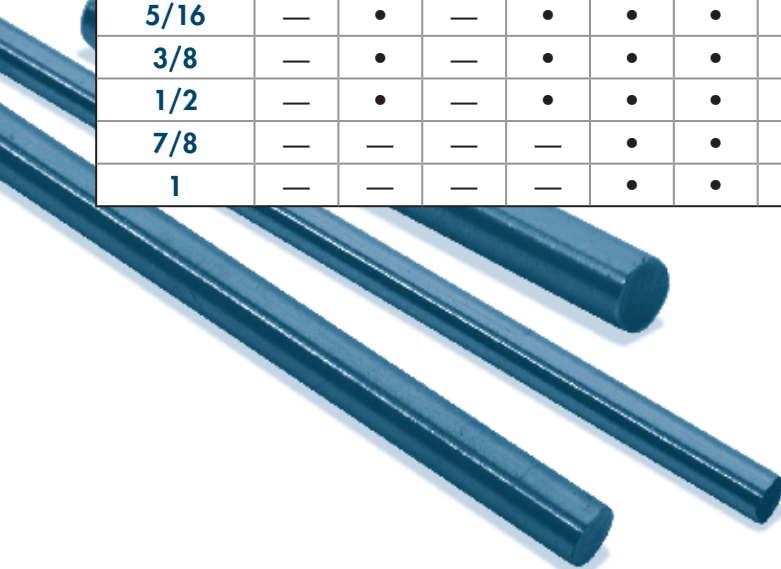

**Key:** — = not available in this size. All dimensions approximate.

**Tolerances:** Up to .5" dia. are ground on O.D. to ± .005 and cut to length ± .010 and .875 - 1" dia. are as cast on O.D. to ± .016 and ± .031 respectively and cut to length ± .031.

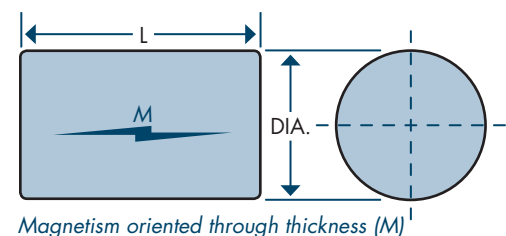

## Alnico 5 Horseshoes

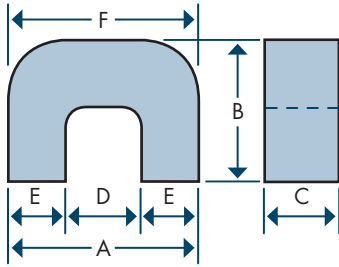

Part No.	Lbs. Pull	Dimensions in Inches						Wgt. (Lbs.)
		A	B	C	D	E	F	
HS012000	12	1.200	1.190	0.400	0.450	0.380	1.380	0.1434
HS170•	3	0.750	1.125	0.250	0.312	0.219	1.125	0.063
HS3702•	13	1.125	0.750	0.750	0.750	0.250	1.125	0.200
HSPH2	1	1.188	1.950	0.250	0.400	0.400	1.188	0.067
HS90	19	1.625	0.844	1.125	0.812	0.406	1.625	0.2840
HS171	22	2.000	1.375	0.609	0.750	0.625	2.000	0.292
HS025000	54	2.500	2.500	0.940	1.600	0.450	2.500	1.087
HSPH1*	3	3.000	3.750	0.750	2.100	0.500	3.000	0.950
HS811N	13	1.187	0.785	0.800	0.590	0.280	1.187	0.1725
HS812N	22	1.590	1.000	1.000	0.750	0.400	1.570	0.3615
HS813N	30	1.770	1.187	1.187	0.875	0.437	1.770	0.5435

Key: • = Magnet is painted red and has a keeper.

\* = Magnet is painted black with North pole marked and has a keeper. Made of 3-1/2% chrome.

All dimensions approximate and as cast with pole faces ground smooth.

Other sizes may be available.

## Alnico 5 Holding Magnets

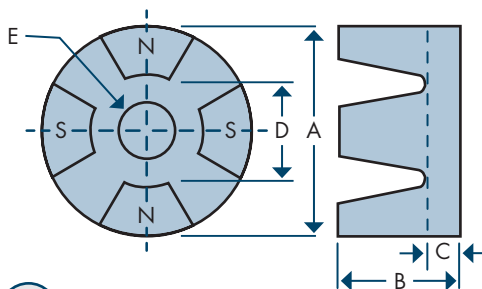

Part No.	Lbs. Pull	No. of Poles	Dimensions in Inches					Wgt. (Lbs.)
			A	B	C	D	E	
AH2E821•	1.5	2	0.500	0.375	0.156	0.281	0.171	0.020
AH25H153	5.0	2	0.687	0.687	0.344	0.344	1.187	0.052
AH23131	4.0	2	0.750	0.500	0.250	0.375	0.218	0.042
AH2CU511	6.0	2	0.875	0.625	0.280	0.375	0.219	0.172
AH2888	9.0	2	0.875	0.875	0.437	0.406	0.250	0.101
AH2823C•	6.0	2	1.000	0.625	0.343	0.343	0.218	0.083
AH43136	16.0	4	1.000	0.750	0.250	0.500	0.250	0.102
AH2225	23.0	2	1.250	1.375	0.687	0.531	0.312	0.344
AH2821N	1.5	2	0.500	0.375	0.165	0.450	0.165	0.0155
AH2822N	4.0	2	0.750	0.500	0.270	0.700	0.190	0.0505
AH2823N	6.0	2	1.000	0.625	0.312	0.933	0.230	0.1210
AH63130	25.0	6	1.250	0.750	0.250	0.625	0.250	0.163
AH2CU512	11.0	2	1.250	0.750	0.312	0.500	0.187	0.172
AH63133	30.0	6	1.500	0.875	0.312	0.750	0.375	0.270
AH83140	65.0	8	2.000	1.250	0.375	1.000	0.500	0.702

Key: • = Painted red and has a keeper.

All dimensions approximate and as cast with pole faces ground smooth.

Other sizes may be available.

# Alnico 5 Channel Horseshoes

Part No.	Dimensions in Inches						Wgt. (Lbs.)
	A	B	C	D	E	F	
<b>ACH1945X2</b>	0.500	0.312	2.000	0.150	0.140	0.200	0.0740
<b>ACH1950</b>	1.500	0.875	0.500	0.500	0.312	0.500	0.1530
<b>ACH1952</b>	1.250	0.750	0.915	0.400	0.250	0.450	0.2011
<b>ACH1950x9WH</b>	1.500	0.875	9.000	0.500	0.325	0.500	2.6120

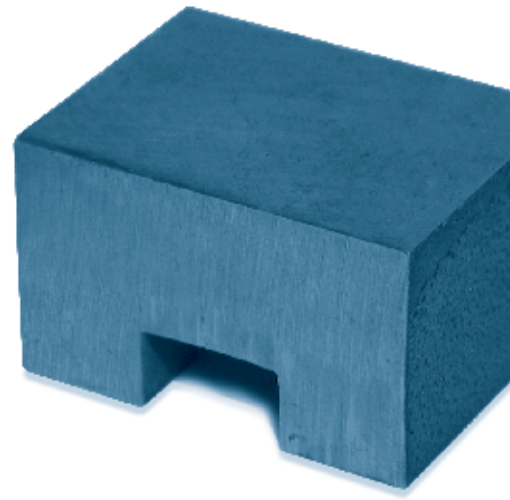

All dimensions approximate and as cast with pole faces ground smooth. Other sizes may be available.  
**Note:** Part No. ACH1945 is available in up to 5" lengths along the "C" dimension. Part No. ACH1950 is available in up to 6" lengths. Part No. ACH79 - all surfaces are ground smooth.

**Other sizes are available.**

Call us with your grade, dimension and tolerance requirements.

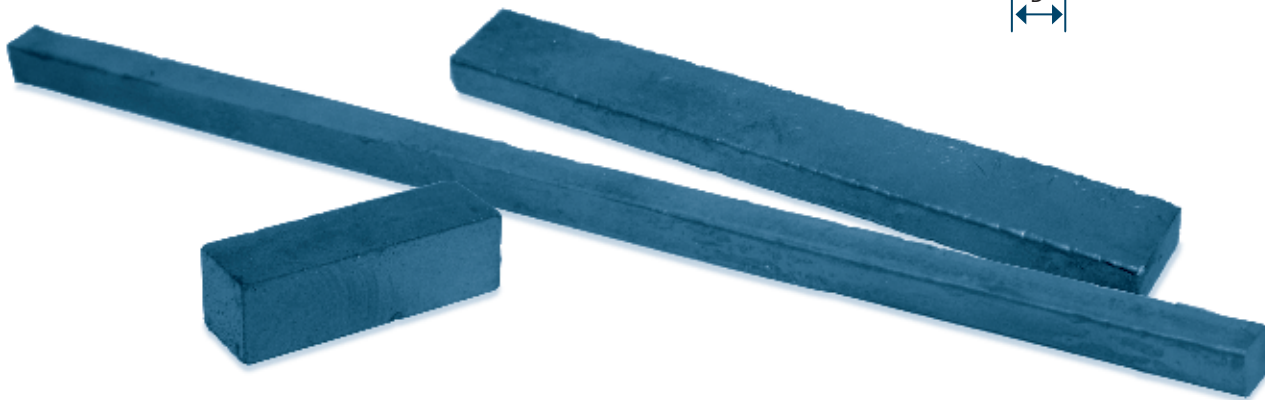
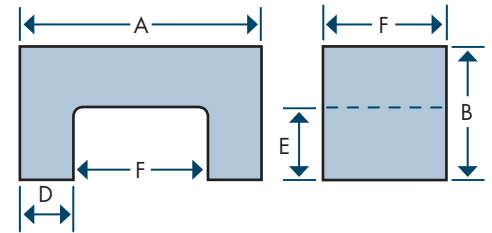

# Alnico 5 Bars

Thickness x Width (in)	Length in Inches											Weight (Lbs./inch)
	1/2	3/4	1	1-1/4	2	3	4	5	6	8	10	
<b>1/4 x 1/4</b>	•	•	•	•	•	•	•	•	•	•	•	0.0167
<b>1/4 x 1/2</b>	•	•	•	•	•	•	•	•	•	•	•	0.0333
<b>1/4 x 1</b>	—	—	•	•	•	•	•	•	•	•	—	0.0667
<b>3/8 x 1</b>	—	—	•	•	•	•	•	•	•	•	•	0.0999
<b>1/2 x 1/2</b>	—	—	•	•	•	•	•	•	•	•	•	0.0667
<b>1/2 x 1</b>	—	—	—	—	•	•	•	•	•	•	•	0.1333
<b>3/4 x 3/4</b>	—	—	—	—	•	•	•	•	•	•	—	0.1490
<b>1 x 1</b>	—	—	—	—	•	•	•	•	•	•	—	0.2650

**Key:** — = not available in this size. All dimensions approximate.

**Tolerances:** As cast - 0" - 1" ± .016 and cut to length ± .010, and 1" - 2" ± .031 and cut to length ± .031. Standard stock items listed above are cast Alnico 5 material. Other grades and lengths may be available.



# Samarium Cobalt Magnets

*Samarium cobalt magnets (SmCo) are composed of samarium, cobalt and iron. These rare earth magnets are extremely strong for their small size, metallic in appearance and found in simple shapes such as rings, blocks and discs.*

**Manufacturing** - In general, the elements are melted together and milled into a powder that is dry-pressed to shape in the presence of a magnetic field. The material is then sintered, aged, ground to dimension, magnetized and tested. They are called "rare earth" magnets because the elements of samarium cobalt are classified as such in the lanthanides section of the Periodic Table of the Elements.

## Attributes of Samarium Cobalt

- High resistance to demagnetization
- High energy (magnetic strength is strong for its size)
- Good temperature stability
- Pricing for samarium cobalt is market sensitive

## Applications of Samarium Cobalt

- Computer disc drives
- Sensors
- Traveling wave tubes
- Linear actuators
- Satellite systems
- Motors where temporary stability is vital

**Tolerances** - For as-pressed material, tolerance on the thickness (direction of magnetization) is  $\pm .005"$ . Other dimensions are  $\pm 2.5%$  or  $\pm .010"$ , whichever is greater.

According to International Magnetics Association/Magnet Materials Producers Association (IMA/MMPA) standards, visual imperfections such as hair-line cracks, porosity and minor chips are commonly found in sintered metallic magnets. A chipped edge is considered acceptable if no more than 10% of the surface is missing. Cracks are acceptable as long as they do not extend across more than 50% of pole surface.

**Magnetizing and Handling** - Samarium cobalt magnets are very brittle and very strong magnetically. Therefore, it is crucial to handle these magnets with extreme care to avoid personal injury and damage to the magnets. Fingers can be severely pinched between attracting magnets. Magnets can chip if allowed to "jump at" an attracting object. It is highly recommended that when constructing rare earth magnetic assemblies, the magnets be magnetized after assembly.

**Machining** - Since samarium cobalt magnet material is prone to chipping and cracking, it does not lend itself to conventional machining methods. It can, however, be abrasively ground, but only with the use of liberal amounts of coolant. The coolant minimizes heat fracturing and the risk of fires caused by oxidized grinding dust.

## Typical Magnetic and Physical Properties of Samarium Cobalt Magnetic Material

Samarium Cobalt Material	Density		Max. Energy Product BH(max) MGO	Residual Induction Br Gauss	Coercive Force Hc Oersteds	Intrinsic Coercive Force (Hci) Oersteds	Maximum Operating Temperature		Curie Temperature	
	lbs/in <sup>3</sup>	g/cm <sup>3</sup>					F°	C°	F°	C°
<b>SmCo 18</b>	0.296	8.2	18.0	8700	8000	20000	482	250	1382	750
<b>SmCo 20</b>	0.296	8.2	20.0	9000	8500	15000	482	250	1382	750
<b>SmCo 24</b>	0.304	8.4	24.0	10200	9200	18000	572	300	1517	825
<b>SmCo 26</b>	0.304	8.4	26.0	10500	9000	11000	572	300	1517	825



# Samarium Cobalt Rings

Part No.	Dimensions in Inches			Approx. Weight (Lbs.)	Grade in MGO
	Outer Dia.	Inner Dia.	Thickness		
<b>SCR754325-18</b>	0.750	0.437	0.250	0.02161	18
<b>SCR013001</b>	1.375	0.750	0.340	0.1063	22

All dimensions approximate. Other sizes and grades may be available.

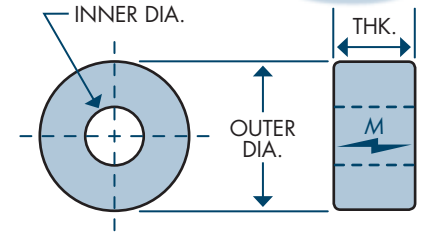
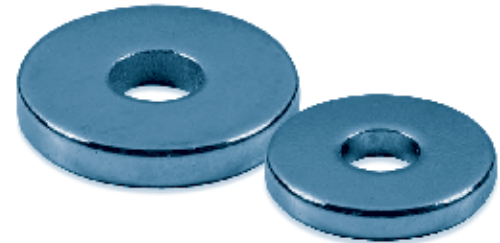

Magnetism oriented through thickness (M)

# Samarium Cobalt Blocks

Part No.	Dimensions in Inches			Approx. Weight (Lbs.)	Grade in MGO
	Thickness	Width	Length		
<b>SCB000990N</b>	0.099	0.772	0.148	0.0034	22
<b>SCB250</b>	0.250	0.500	1.000	0.0380	22
<b>SCB2555-26</b>	0.250	0.500	0.500	0.1880	26
<b>SCB400</b>	0.500	0.550	2.000	0.1650	24
<b>SCB500</b>	0.500	2.000	2.000	0.5920	18

All dimensions approximate. Other sizes and grades may be available.

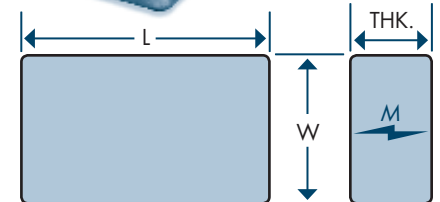

Magnetism oriented through thickness (M)

# Samarium Cobalt Discs

Part No.	Dimensions in Inches		Approx. Weight (Lbs.)	Grade in MGO
	Diameter	Thickness		
<b>SCD002503N</b>	0.250	0.060	0.00090	18
<b>SCD004500</b>	0.177	0.079	0.00060	20
<b>SCD118N</b>	0.118	0.118	0.00038	20
<b>SCD156</b>	0.156	0.060	0.00034	18
<b>SCD187</b>	0.187	0.060	0.00048	18
<b>SCD188N</b>	0.187	0.080	0.00065	18
<b>SCD25N</b>	0.250	0.100	0.00145	18
<b>SCD26</b>	0.250	0.125	0.00181	18
<b>SCD2525</b>	0.250	0.250	0.00363	18
<b>SCD375</b>	0.375	0.125	0.00408	18
<b>SCD3751</b>	0.375	0.060	0.00196	18
<b>SCD3752</b>	0.375	0.250	0.00817	18
<b>SCD500</b>	0.500	0.060	0.00348	18
<b>SCD518</b>	0.500	0.187	0.01086	18
<b>SCD625N</b>	0.625	0.060	0.00559	24

**NOTE:** An "N" in the part number indicates nickel plating. **Tolerances:** ± .020 on diameter, ± .005 on thickness. Other sizes and grades may be available. All dimensions approximate.

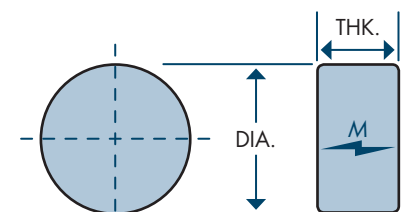

Magnetism oriented through thickness (M)

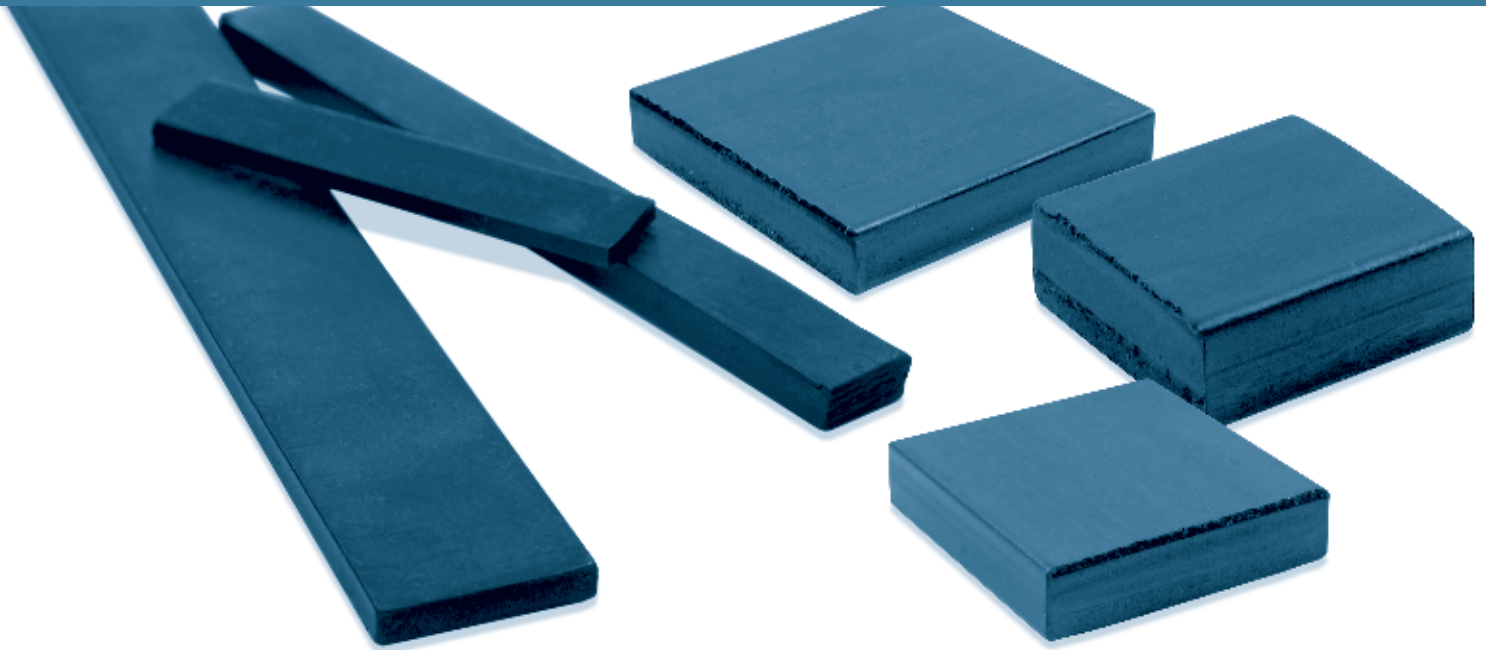

## High Energy Flexible Magnets

*High Energy Flexible Magnets are composed of a strontium ferrite powder mixture with polymer bonding. These magnets are most commonly formed as strip.*

### Custom Orders and Manufacturing

High Energy Flexible Magnets are commonly manufactured in the forms of strips, sheets or die-cut pieces. High energy strip and sheets are available in a variety of energy levels. Some stock sizes with or without adhesive are available for immediate purchase, but we encourage you to contact us regarding your specific needs. Please provide the shape, size, thickness of material and tolerances

needed. Also let us know whether or not your application requires an adhesive. Providing a drawing and description of the application is also helpful in quoting the correct magnet. Please let us know whether ferrous metal backing plates or other magnetic circuit enclosures will be used in your application. Fax your request and drawing toll-free to **1.800.874.6248**, or e-mail to **pmm@magnetsource.com**.

**Many shapes and sizes are available in stock now • Minimum quantities may apply to custom orders**

*Call us with your grade, dimension and tolerance requirements.*

### Typical Magnetic and Physical Properties of High Energy Flexible Magnet Material

High Energy Material (BH Max)	Density		Maximum Energy Product	Residual Induction Br	Coercive Force Hc	Intrinsic Coercive Force (Hci)
	lbs/in <sup>3</sup>	g/cm <sup>3</sup>	MGO	Gauss	Oersteds	Oersteds
<b>1.1</b>	0.128	3.542	1.10	2200	1900	2400
<b>1.2</b>	0.128	3.542	1.20	2300	1950	2400
<b>1.3</b>	0.128	3.542	1.30	2350	2000	2900
<b>1.4</b>	0.128	3.542	1.40	2450	2100	2900

# Manufacturing, Attributes and Applications

**Manufacturing High Energy Flexible Magnets** - The raw material goes through a calendaring process and then is formed into strip. It can then be easily machined to size and magnetized. High energy flexible magnets are anisotropic (oriented), whereas standard flexible magnetic material is not. Therefore, high energy magnets are limited to magnetization through the thickness, and are similar in strength to a Grade 1 ceramic magnet. Special magnetizing patterns available and may require fabrication of magnetizing fixtures.

## Attributes of High Energy Flexible Magnets

- Higher resistance to demagnetization compared to standard flexible magnet material
- Easy fabrication and handling
- Free from chipping, cracking or shattering
- Inexpensive
- High energy product versus regular flexible material
- Adhesive or plain
- Low curie point, not good in heat applications

## Chemical Resistance:

Weather	=	Excellent
Water	=	Excellent
Ozone	=	Excellent
Dilute Acids	=	Good
Dilute Bases	=	Good
Oils	=	Poor

*Call us with your application requirements*

*Minimum quantities may apply*

*High energy shapes, strips and die cuts available now*

*Call for sizes and shapes*

## Flexible Magnet Pole Patterns

**A. Conventional Magnetization:** Has one pole on each side of the magnet – North pole on one side, South pole on the other.

**B. Multiple Pole:** Two Poles (**B1**) or Multiple Poles (**B2**) on each side – two or more sets of poles on each surface are used in open circuit designs. North and South poles alternate through the thickness of the material. Steel backing is desirable where practical.

## Applications of High Energy Flexible Magnets

- Motors
- Sensors
- Latches
- Magnetic Assemblies
- Electronics
- Appliances
- Holding
- Actuators
- Seals

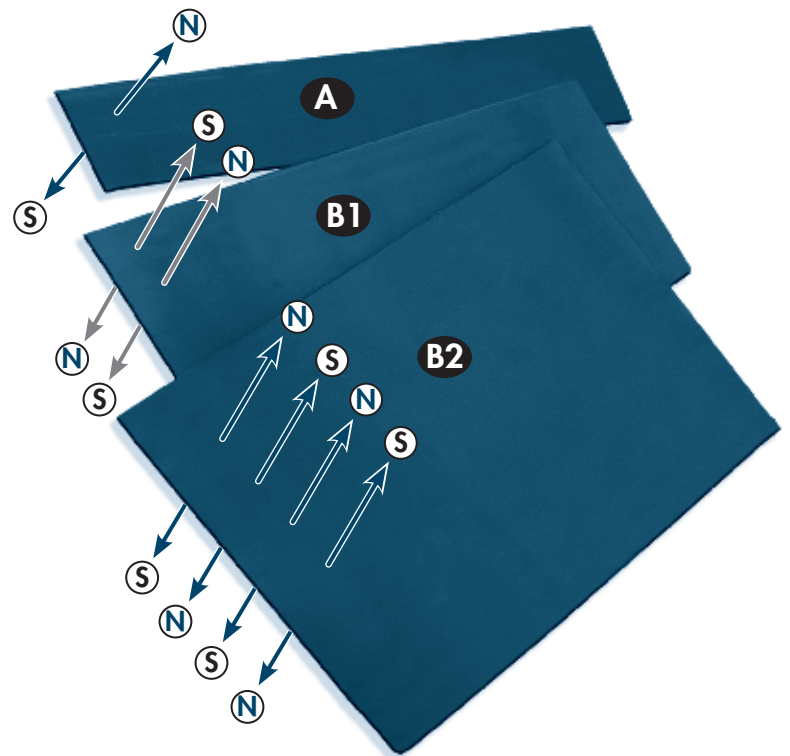

*To review our selection of flexible magnetic sheeting and strip, please refer to our flexible magnet catalog or check our website for information.*

# Gaussmeters, Magnetizers and Pole Indicators

## Gaussmeter

**A. Part No. GM-2** - The DC Gaussmeter is a very accurate instrument useful in measuring the DC magnetic field intensity of magnets, magnetic devices and assemblies, as well as relays, electromagnets, motors, generators, loudspeakers, actuators, ferrite content in non-ferrous materials and more!

Typical applications include magnet classification, analysis of magnetic circuitry and components, air shipment inspection, measurements of the earth's field vectors, mapping and recording field perturbations, Magnetic Resonance Imaging (MRI) and measuring residual fields.

Reference magnet, batteries, AC power adaptor, transverse probe and durable carrying case included.



## Self-Contained Magnetizer

**B. Part No. MAG24C**

Capacity . . . . . 24,500 Amp / turns  
 Size . . . . . 10-1/8" L x 5-1/8" W x 7-9/16" H  
 Weight . . . . . 40 lbs.

Will magnetize Alnico 5 up to 2" x 3" long and Ceramic 5 up to 2" x 2-1/2" long (typically used for alnico). Connects to standard 120 VAC (50/60 Cycles, 14 Amps) outlet. Adjust tapered pole shoes (up to 4" gap) to fit magnet length.

The following magnetizing forces are recommended by magnet manufacturers for various magnetic materials, expressed in Amp/turns required per inch of length of magnet material:

Alnico 1, 2, 3 . . . . . 4000 Amp / turns / inch  
 Alnico 5, 6 . . . . . 6000 Amp / turns / inch  
 Alnico 8, 9 . . . . . 10,000 Amp / turns / inch  
 (varies by grade)  
 Ceramic . . . . . 20,000 Amp / turns / inch  
 SmCo and NdFeB require capacitor discharge units.

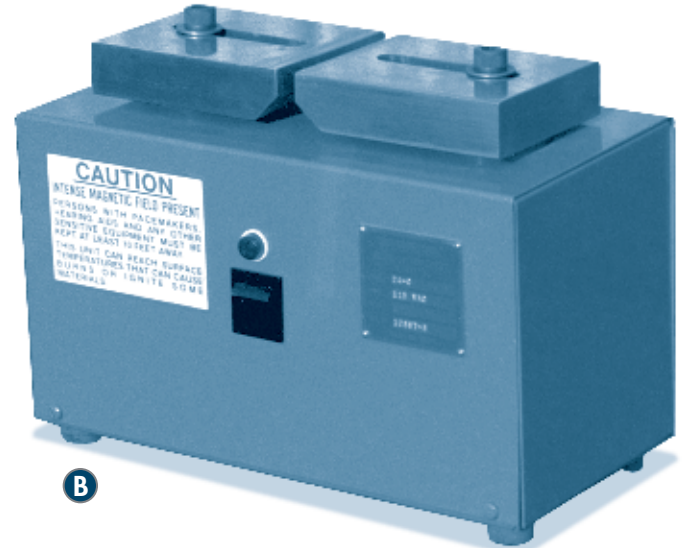

## Magnetic Pole Indicators

**C. Part No. POLEIND01** - Simply point the North-South pole indicator toward the magnet and read the pole letter in the viewing hole. No batteries required.

**D. Part No. POLEIND02** - The electronic North-South pole indicator features LED lights to identify pole locations. Includes pocket clip, on/off switch and four LR44 batteries.



# Neodymium Magnetic Latches

These powerful magnetic assemblies are designed to be used as door latches for cabinets, chests, displays and more. Simply attach the magnet in a steel cup to one surface and the strike plate to the other to make a secure closure. Counterbore a hole in the wood for flush mounting. Available in 5 sizes with magnetic pull strengths ranging from 2 to 30 pounds. Mounting screws also available.

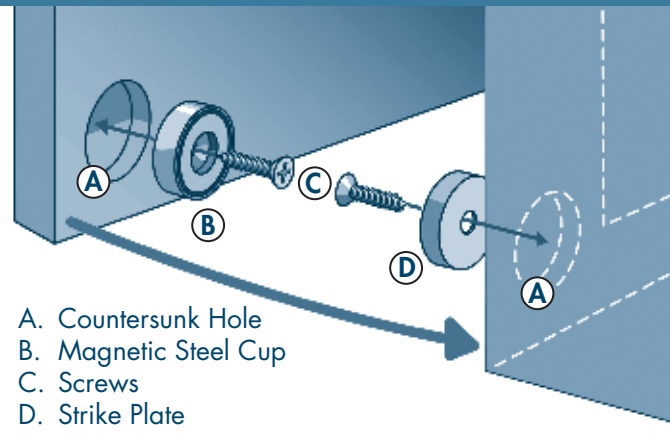

- A. Countersunk Hole
- B. Magnetic Steel Cup
- C. Screws
- D. Strike Plate

2 Lbs. Pull	Dimensions in Inches		Part No.
	Outer Dia.	Thickness	
Steel Cup (press fit)	0.380	0.250	<b>ZZRB11CUPZ</b>
Strike Plate	0.375	0.094	<b>ZZFWNM38Z</b>
Neo Magnet Disc	0.250	0.080	<b>ND002507N</b>
Screw: #4 Phillips (1)		0.500	<b>ZZFWS4X.5</b>

6 Lbs. Pull	Dimensions in Inches		Part No.
	Outer Dia.	Thickness	
Steel Cup	0.500	0.250	<b>ZZRB12CUPZ</b>
Strike Plate	0.500	0.094	<b>ZZFWNM50Z</b>
Neo Magnet Disc	0.360	0.075	<b>ND003602N</b>
Screw: #4 Phillips (2)		0.500	<b>ZZFWS4X.5</b>

16 Lbs. Pull	Dimensions in Inches		Part No.
	Outer Dia.	Thickness	
Steel Cup	0.625	0.250	<b>ZZRB13CUPZ</b>
Strike Plate	0.625	0.094	<b>ZZFWNM625Z</b>
Neo Magnet Disc	0.490	0.105	<b>ND004903N</b>
Screw: #8 Phillips (2)		0.750	<b>ZZFWS8X.75</b>

23 Lbs. Pull	Dimensions in Inches			Part No.
	Outer Dia.	Inner Dia.	Thickness	
Steel Cup	0.875	–	0.281	<b>ZZRB14CUPZ</b>
Strike Plate	0.875	–	0.156	<b>ZZFWNM875Z</b>
Neo Magnet Ring	0.740	0.375	0.105	<b>NR007403N</b>
Screw: #8 Phillips (2)		–	0.750	<b>ZZFWS8X.75</b>

30 Lbs. Pull	Dimensions in Inches			Part No.
	Outer Dia.	Inner Dia.	Thickness	
Steel Cup	1.130	–	0.270	<b>ZZRB15CUPZ</b>
Strike Plate	1.130	–	0.150	<b>ZZFWNM1.13Z</b>
Neo Magnet Ring	1.000	0.500	0.110	<b>NR010007N</b>
Screw: #8 Phillips (2)		–	0.750	<b>ZZFWS8X.75</b>

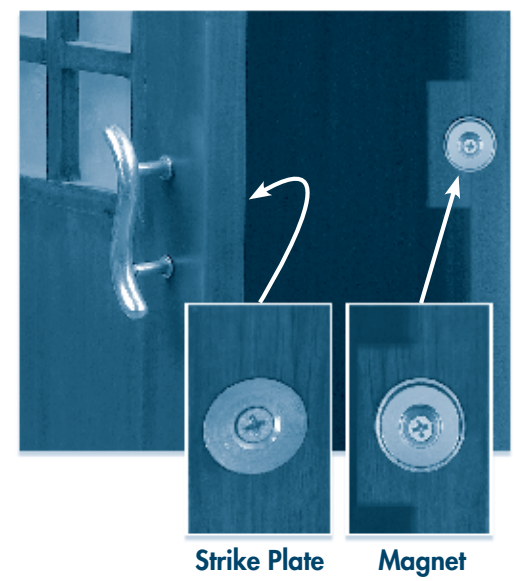
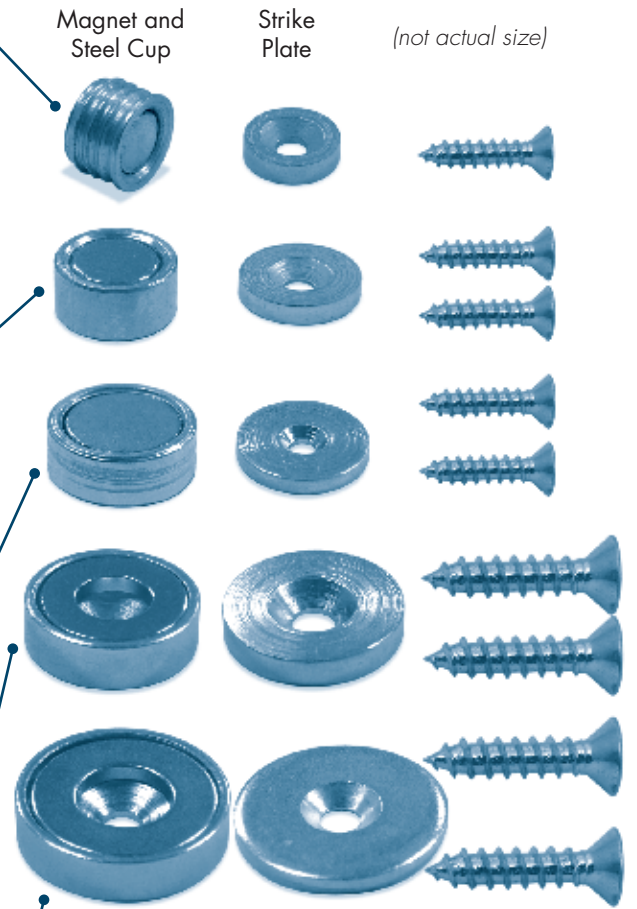

# Magnetic Field Viewer

Use this amazing film to view the location and number of poles on any magnet. Magnetic poles appear as dark areas and the light areas represent where North and South poles meet. This material is available in large sheets which may be cut to size, or in a durable laminated card size.

Part No.	Description
MVP1	12" x 12" sheet of field viewing film
MVP2	18" x 36" sheet of field viewing film
DMVC-1	2-1/2" x 4" laminated field viewer card (right)



## Glossary of Magnet Terminology

**Anisotropic (oriented)** - The material has a preferred direction of magnetic orientation.

**Coercive Force, H<sub>c</sub>** - The demagnetizing force, in oersteds, required to reduce the residual induction, B<sub>r</sub>, of a fully magnetized magnet to zero.

**Curie Temperature** - Temperature at which a material loses its magnetic properties.

**Gauss** - Unit of measure of magnetic induction, B, or flux density in the CGS system.

**Gaussmeter** - An instrument used to measure the instantaneous value of magnetic induction, B.

**Hysteresis Loop** - A closed curve obtained for a material. Obtained by plotting corresponding values of magnetic induction, B, for ordinates and magnetizing force, H, for abscissa when the material is passing through a complete cycle between definite limits of either magnetizing force, H, or magnetic induction, B. This data is usually plotted to rectangular coordinates.

*An example of a hysteresis loop can be found on the back cover of this catalog.*

**Intrinsic Coercive Force, H<sub>ci</sub>** - Oersted measurement of the material's inherent ability to resist self-demagnetization.

**Isotropic (non-oriented)** - The material has no preferred direction of magnetic orientation, which allows magnetization in any direction.

**Magnetic Field Strength (magnetizing or demagnetizing force)** - The measure of the vector magnetic quantity that determines the ability of an electric current, or a magnetic body, to induce a magnetic field at a given point; measured in oersteds.

**Magnetic Induction, B** - Flux per unit area of a section normal to the direction of the magnetic path. Measured in gauss.

**Maximum Energy Product, BH<sub>max</sub>** - The maximum product of (BdHd) which can be obtained on the demagnetization curve.

**Maximum Operating Temperature** - The maximum temperature of exposure that a magnet can forego without significant long-range instability or structural changes.

**North Pole** - That magnetic pole which attracts the geographic North pole.

**Residual Induction, B<sub>r</sub>** - Flux density, measured in gauss, of a magnetic material after being fully magnetized in a closed circuit.

### Handy Conversion Tables

#### Temperature

$$F^{\circ} = (C^{\circ} \times 1.8) + 32$$

$$C^{\circ} = \frac{F^{\circ} - 32}{1.8}$$

#### Length

$$\text{in} = \text{cm} \times .3937$$

$$\text{in} = \text{mm} \times .03937$$

$$\text{cm} = \text{in} \times 2.54$$

$$\text{mm} = \text{in} \times 25.4$$

#### Weight

$$\text{MASS} = \text{DNSTY} \times \text{VOLUME}$$

$$\text{lbs} = \text{kg} \times 2.2046$$

$$\text{lbs} = \text{g} \times .0022$$

$$\text{kg} = \text{lbs} \times .4536$$

$$\text{g} = \text{lbs} \times 453.6$$

#### Density

$$\text{lbs} / \text{in}^3 = \text{g} / \text{cm}^3 \times .03613$$

$$\text{g} / \text{cm}^3 = \frac{\text{lbs} / \text{in}^3}{.03613}$$

# Typical Magnetization Pole Patterns

**Oriented (anisotropic):** Has better magnetic properties in a given direction. During the manufacturing process, a magnetic field is applied in the direction of preferred magnetization to orient the material and increase the magnet's performance potential. With oriented material, multiple pole magnetization flux goes "through" the magnet making both sides of the magnet strong.

**Non-oriented (isotropic):** Has equal magnetic properties in all directions. During the manufacturing process the magnet is not exposed to a magnetic field. This material can be magnetized in any magnetization pattern. This material is weaker than oriented materials. With non-oriented material, multiple pole magnetization flux bends inside the magnet making it strong on one side only.

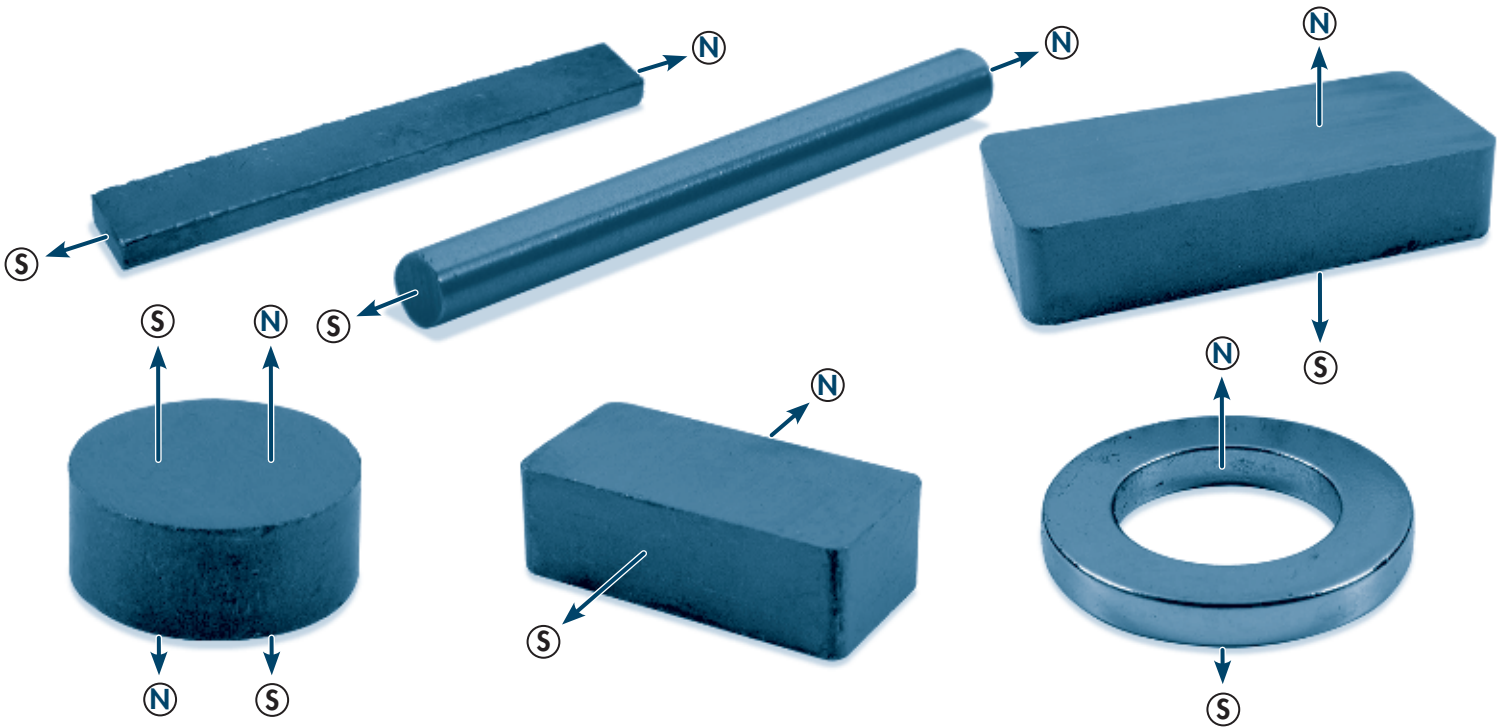

The following magnetization patterns apply to both oriented and non-oriented magnet materials:

## Bars

*Through the length*  
Magnetized North on one end and South on the other.

## Rods

*Through the length or axial*  
Magnetized North on one end and South on the other.

## Blocks

*Through the thickness*  
Magnetized North on one side of the thickness and South on the other.

## Discs

*Multiple poles (two sets or more) on a surface magnetized through the thickness*  
Magnetized with more than one set of N/S poles on one or both faces of the magnet.

## Bar or Block

*Through the width or across the width*  
Magnetized North on one side of width and South on the other.

## Disc or Ring

*Through the thickness*  
Magnetized North on one face of the disc or ring and South on the other.

MASTER MAGNETICS, INC.



The Magnet Source™ serves customers worldwide. No matter what your application, we can serve you quickly and easily thanks to our large inventory and warehousing capabilities. We have over 15 million magnets in stock and excellent resources for raw material magnets, plus the machinery to cut, grind and magnetize magnets to meet your needs. Our other manufacturing capabilities allow us to produce a wide variety of magnetic assemblies. Contact one of our customer service team members today for assistance.



U.S.A. and International  
**Master Magnetics, Inc.**  
747 S. Gilbert Street  
Castle Rock, Colorado 80104  
Toll-Free: 1.888.293.9399  
Colorado: 303.688.3966  
Fax: 1.800.874.6248  
[www.magnetsource.com](http://www.magnetsource.com)

California and Hawaii  
**A-L-L Magnetics, Inc.**  
2831 Via Martens  
Anaheim, California 92806  
Toll Free: 1.800.262.4638  
Local: 714.632.1754  
Fax: 714.632.1757  
[www.allmagnetics.com](http://www.allmagnetics.com)

Southeastern U.S.A.  
**Miami Magnet Co.**  
6073 NW 167th Street, Suite C26  
Miami, Florida 33015  
Toll Free: 1.800.222.7846  
Local: 305.823.0641  
Fax: 305.823.1603  
[www.magnetsource.com](http://www.magnetsource.com)