

## MAGNETICS KOOL M $\mu$ <sup>®</sup> E-CORES

### Introduction

Kool M $\mu$ <sup>®</sup> powder cores are made of a ferrous alloy powder, which has low losses at elevated temperatures. Kool M $\mu$  E-cores have a distributed air gap which makes them ideally suited for switching regulator inductors, flyback transformers, and power factor correction (PFC) inductors. The 10,500 gauss saturation level of Kool M $\mu$  provides a higher energy storage capability than can be obtained with gapped ferrite E-cores, resulting in smaller core size. Kool M $\mu$  E-cores are competitively priced against gapped ferrite E-cores and their distributed air gap eliminates gap loss problems associated with ferrites. Kool M $\mu$  E-cores have significantly lower losses and substantially better thermal properties when compared to powdered iron E-cores.

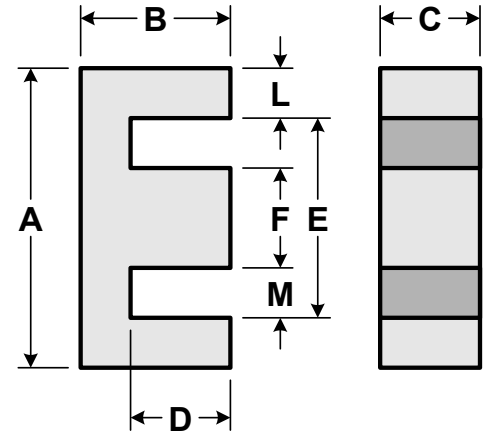

Figure 1

Table 1

| PART NO.                 |            | A                    | B                    | C                    | D (min)         | E (min)         | F                    | L (nom)        | M (min)         |
|--------------------------|------------|----------------------|----------------------|----------------------|-----------------|-----------------|----------------------|----------------|-----------------|
| 00K1207E<br>(EF 12.6)    | in<br>(mm) | 0.500±.010<br>(12.7) | 0.252±.004<br>(6.4)  | 0.140±.006<br>(3.6)  | 0.178<br>(4.4)  | 0.350<br>(8.9)  | 0.140±.005<br>(3.6)  | 0.070<br>(1.8) | 0.104<br>(2.6)  |
| 00K1808E<br>(EI-187)     | in<br>(mm) | 0.760±.012<br>(19.3) | 0.319±.007<br>(8.1)  | 0.188±.006<br>(4.8)  | 0.218<br>(5.5)  | 0.548<br>(13.9) | 0.188±.005<br>(4.8)  | 0.094<br>(2.4) | 0.183<br>(4.6)  |
| 00K2510E<br>(E-2425)     | in<br>(mm) | 1.000±.015<br>(25.4) | 0.375±.007<br>(9.5)  | 0.250±.004<br>(6.5)  | 0.245<br>(6.2)  | 0.740<br>(18.8) | 0.250±.005<br>(6.2)  | 0.125<br>(3.2) | 0.246<br>(6.3)  |
| 00K3007-E<br>(DIN 30/7)  | in<br>(mm) | 1.185±.018<br>(30.1) | 0.591±.009<br>(15)   | 0.278±.006<br>(7.1)  | 0.376<br>(9.7)  | 0.768<br>(19.5) | 0.274±.008<br>(6.9)  | 0.201<br>(5.1) | 0.254<br>(6.5)  |
| 00K3515E<br>(EI-375)     | in<br>(mm) | 1.360±.020<br>(34.5) | 0.557±.009<br>(14.1) | 0.368±.007<br>(9.4)  | 0.378<br>(9.6)  | 0.995<br>(25.3) | 0.367±.008<br>(9.3)  | 0.175<br>(4.4) | 0.310<br>(7.9)  |
| 00K4017E<br>(EE 42/11)   | in<br>(mm) | 1.687±.025<br>(42.8) | 0.830±.013<br>(21.1) | 0.424±.010<br>(10.8) | 0.587<br>(15)   | 1.195<br>(30.4) | 0.468±.010<br>(11.9) | 0.234<br>(5.9) | 0.365<br>(9.3)  |
| 00K4020E<br>(DIN 42/15)  | in<br>(mm) | 1.687±.025<br>(42.8) | 0.830±.013<br>(21.1) | 0.608±.010<br>(15.4) | 0.587<br>(15)   | 1.195<br>(30.4) | 0.468±.010<br>(11.9) | 0.234<br>(5.9) | 0.365<br>(9.3)  |
| 00K4022E<br>(DIN 42/20)  | in<br>(mm) | 1.687±.025<br>(42.8) | 0.830±.013<br>(21.1) | 0.788±.010<br>(20)   | 0.587<br>(15)   | 1.195<br>(30.4) | 0.468±.010<br>(11.9) | 0.234<br>(5.6) | 0.365<br>(9.3)  |
| 00K4317E<br>(EI-21)      | in<br>(mm) | 1.609±.024<br>(40.9) | 0.650±.011<br>(16.5) | 0.493±.007<br>(12.5) | 0.409<br>(10.4) | 1.115<br>(28.3) | 0.493±.008<br>(12.5) | 0.238<br>(6)   | 0.310<br>(7.9)  |
| 00K5528E<br>(DIN 55/21)  | in<br>(mm) | 2.16±.032<br>(54.9)  | 1.085±.016<br>(27.6) | 0.812±.015<br>(20.6) | 0.729<br>(18.5) | 1.476<br>(37.5) | 0.660±.015<br>(16.8) | 0.330<br>(8.4) | 0.405<br>(10.3) |
| 00K5530E<br>(DIN 55/25)  | in<br>(mm) | 2.16±.032<br>(54.9)  | 1.085±.016<br>(27.6) | 0.969±.015<br>(24.6) | 0.729<br>(18.5) | 1.476<br>(37.5) | 0.660±.015<br>(16.8) | 0.330<br>(8.4) | 0.405<br>(10.3) |
| 00K6527E<br>(Metric E65) | in<br>(mm) | 2.563±.050<br>(65.1) | 1.279±.150<br>(32.5) | 1.063±.016<br>(27)   | 0.874<br>(22.2) | 1.740<br>(44.2) | 0.775±.012<br>(19.7) | 0.394<br>(10)  | 0.476<br>(12.1) |
| 00K7228E<br>(F11)        | in<br>(mm) | 2.850±.043<br>(72.4) | 1.100±.020<br>(27.9) | 0.750±.015<br>(19.1) | .699<br>(17.8)  | 2.072<br>(52.6) | 0.750±.015<br>(19.1) | 0.375<br>(9.5) | 0.665<br>(16.9) |
| 00K8020E<br>(Metric E80) | in<br>(mm) | 3.150±.047<br>(80)   | 1.500±.025<br>(38.1) | 0.780±.015<br>(19.8) | 1.103<br>(28.1) | 2.334<br>(59.3) | 0.780±.015<br>(19.8) | 0.390<br>(9.9) | 0.780<br>(19.8) |

## Materials and DC Bias

Kool M $\mu$  E-cores are available in four permeabilities, 26 $\mu$ , 40 $\mu$ , 60 $\mu$ , and 90 $\mu$ . The magnetic data for each core is shown in the table below. The most critical parameter of a switching regulator inductor material is its ability to provide inductance, or permeability, under DC bias. Figure 2 shows the reduction in permeability as a function of DC bias. The distributed air gap of Kool M $\mu$  results in a soft inductance versus DC bias curve. In most applications, this swinging inductance is desirable since it improves efficiency and accommodates a wide operating range. With a fixed current requirement, the soft inductance versus DC bias curve provides added protection against overload conditions. Figure 2 is plotted on a semi-log scale to show the DC bias characteristics at high current.

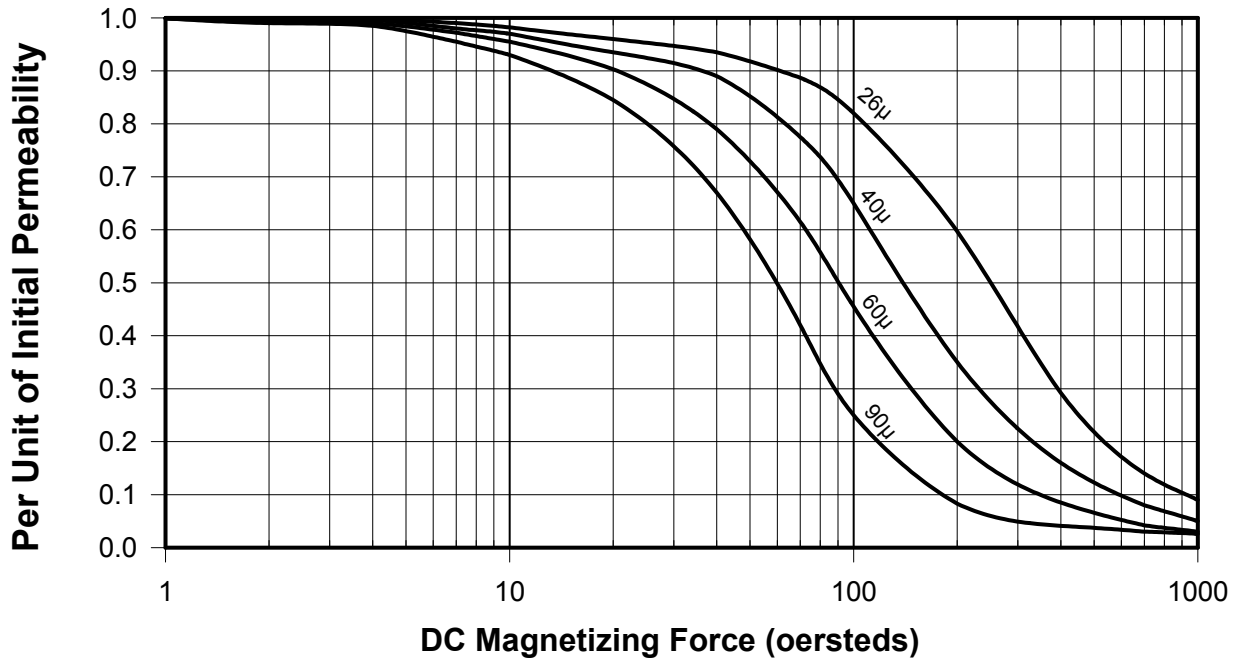

Figure 2

Table 2

| PART NO.    | A <sub>L</sub> mH/1000 turns $\pm 8\%$ |          |          |          | Path Length<br>l <sub>e</sub> (cm) | Cross Section<br>A <sub>E</sub> (cm <sup>2</sup> ) | Volume<br>V <sub>E</sub> (cm <sup>3</sup> ) |
|-------------|--|----------|----------|----------|------------------------------------|--|---|
|             | 26 $\mu$                               | 40 $\mu$ | 60 $\mu$ | 90 $\mu$ |                                    |  |   |
| 00K1207E*** | -                                      | -        | -        | -        | 2.96                               | 0.13   | 0.385                                       |
| 00K1808E*** | 26                                     | 35       | 48       | 69       | 4.01                               | 0.228  | 0.914                                       |
| 00K2510E*** | 39                                     | 52       | 70       | 100      | 4.85                               | 0.385  | 1.87  |
| 00K3007E*** | 33                                     | 46       | 71       | 92       | 6.56                               | 0.601  | 3.94  |
| 00K3515E*** | 56                                     | 75       | 102      | 146      | 6.94                               | 0.84   | 5.83  |
| 00K4017E*** | 56                                     | 76       | 105      | 151      | 9.84                               | 1.28   | 12.6  |
| 00K4020E*** | 80                                     | 108      | 150      | 217      | 9.84                               | 1.83   | 18  |
| 00K4022E*** | 104                                    | 140      | 194      | 281      | 9.84                               | 2.37   | 23.3  |
| 00K4317E*** | 88                                     | 119      | 163      | 234      | 7.75                               | 1.52   | 11.8  |
| 00K5528E*** | 116                                    | 157      | 219      | NA       | 12.3                               | 3.5  | 43.1  |
| 00K5530E*** | 138                                    | 187      | 261      | NA       | 12.3                               | 4.17   | 51.4  |
| 00K6527E*** | -                                      | -        | -        | NA       | 14.7                               | 5.4  | 79.4  |
| 00K7228E*** | -                                      | -        | -        | NA       | 13.7                               | 3.68   | 50.3  |
| 00K8020E*** | 103                                    | 145      | 190      | NA       | 18.5                               | 3.89   | 72.1  |

\*\*\* Add permeability code to part number, e.g., for 60 $\mu$  the complete part number is 00K1808E060

## Comparison to Gapped Ferrite

Although high grade ferrite core losses are lower than Kool M $\mu$  core losses, ferrite often requires low effective permeability to prevent saturation at high current levels. Ferrite, with its high initial permeability, requires a relatively large air gap to get a low effective permeability. This large air gap results in gap loss, a complex problem which is often overlooked when comparing material loss curves. Simply put, gap loss can drastically increase losses due to fringing flux around the air gap (Figure 3). The fringing flux intersects the copper windings, creating excessive eddy currents in the wire.

With more than twice the flux capacity of ferrite, Kool M $\mu$  offers significantly better DC bias characteristics (Figure 4). At a typical 50% roll-off, this can result in a 35% reduction in core size and a more robust design that utilizes the soft saturation of Kool M $\mu$ . The flux capacity difference is even more dramatic at high temperatures, since the flux capacity of ferrites decrease with temperature while Kool M $\mu$  stays relatively constant.

Gapped ferrite cores do have advantages over Kool M $\mu$  E-cores. Gapped ferrites typically have a  $\pm 3\%$  tolerance on inductance compared to Kool M $\mu$ 's  $\pm 8\%$ . Gapped ferrites are available in a much wider selection of sizes and shapes. Since ferrite material can have a higher gapped effective permeability it is well suited for relatively low bias applications, such as feed forward transformers and low biased inductors.

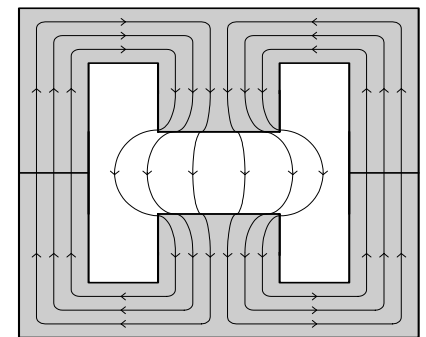
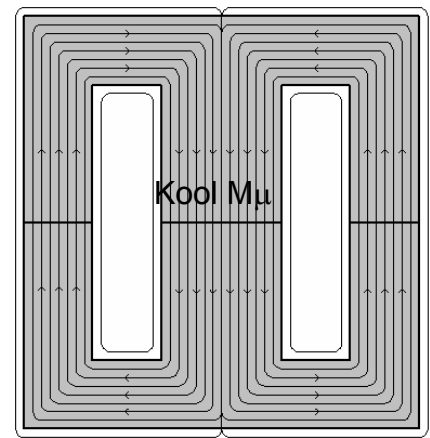

Gapped Ferrite

**Figure 3**

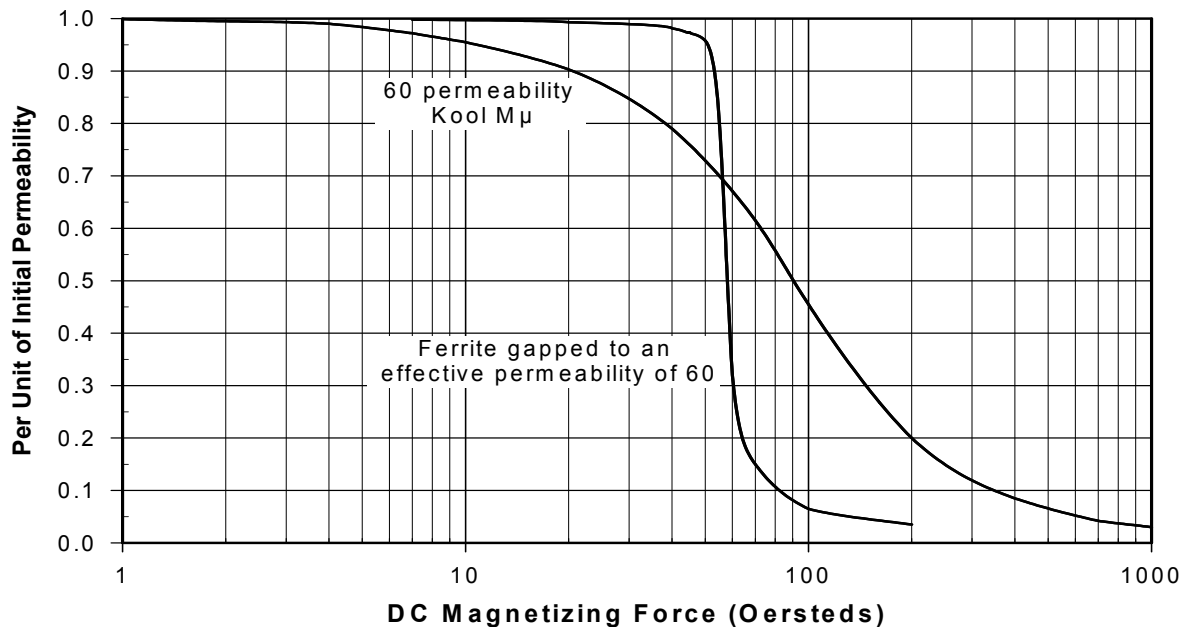

**Figure 4**

## Comparison to Powdered Iron

Kool M $\mu$ 's main advantage over powdered iron is its lower core losses, see Figure 5. Also, Kool M $\mu$ , (Al, Si, Fe composition) offers similar DC bias characteristics when compared to powdered iron (pure Fe composition), see Figure 6. In addition to withstanding a DC bias, switching regulator inductors see some AC current, typically at 10 kHz to 300kHz. This AC current produces a high frequency magnetic field, which creates core losses and causes the core to heat up. This effect is lessened with Kool M $\mu$ , therefore inductors are more efficient and run cooler. Additionally, Kool M $\mu$  has near zero magnetostriction, eliminating the audible noise associated with powdered iron cores, ferrite, or silicon iron laminations when they are operated in the 20Hz to 20kHz range.

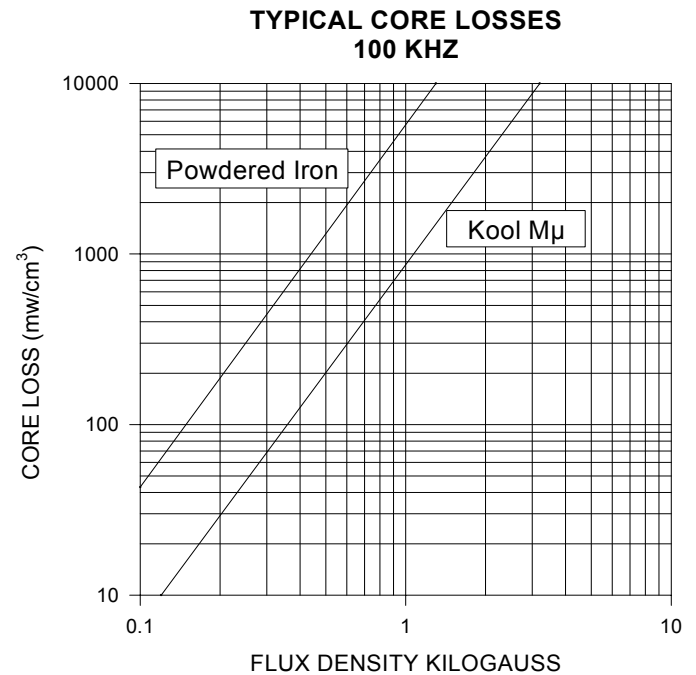

**Figure 5**

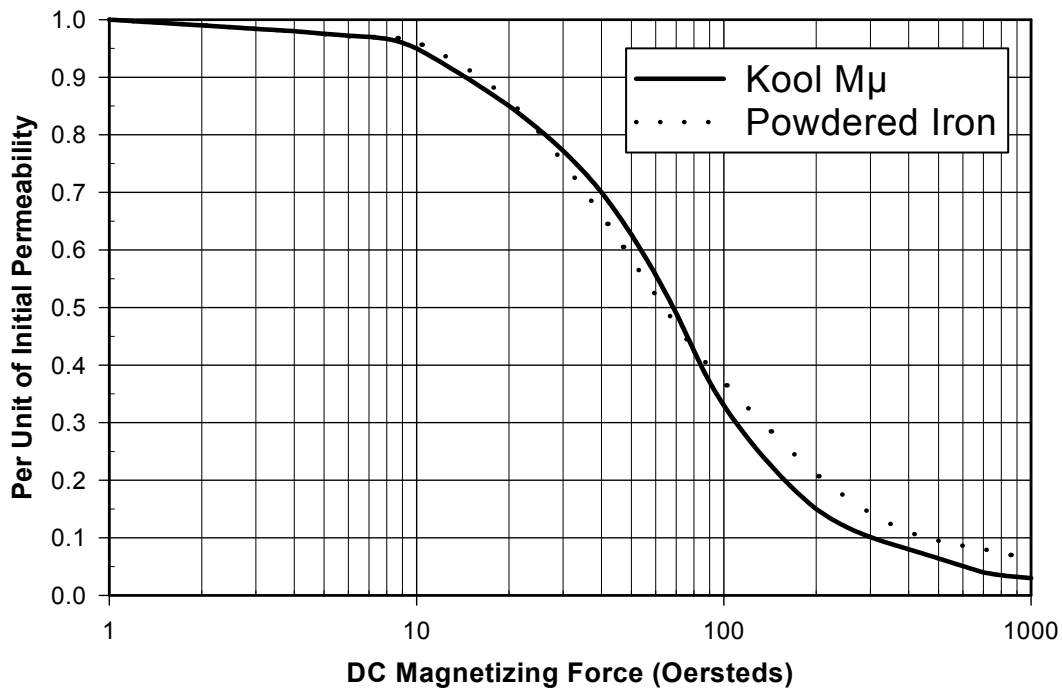

**Figure 6**

## Performance over Temperature

With a Curie temperature of approximately 500°C and rated for continuous operation from -65°C up to +200°C, Kool M $\mu$  offers excellent performance over temperature. Unlike powdered iron, Kool M $\mu$  is manufactured without the use of an organic binder. Therefore, Kool M $\mu$  has none of the thermal aging concerns associated with powdered iron cores. Kool M $\mu$  also has a relatively stable inductance over temperature, see Figure 7. Unlike some ferrite materials, Kool M $\mu$  does not have increasing losses over temperature. Additionally, Kool M $\mu$  does not have a significant decrease in saturation flux density at high temperature, a characteristic that lowers ferrite's DC bias handling ability.

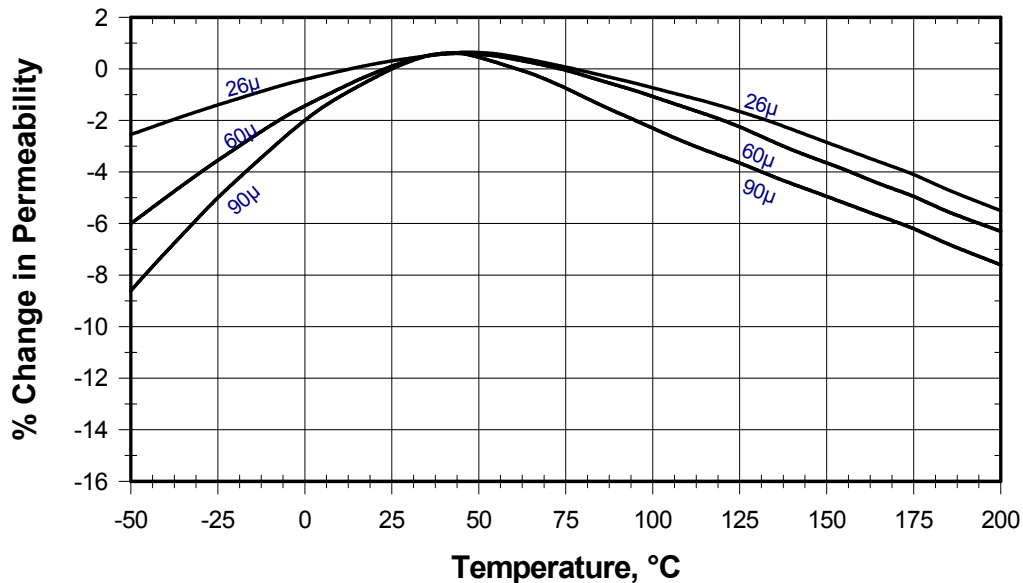

Figure 7

## Leakage Flux

Leakage Flux occurs when some of the magnetic field is not contained within the core structure. All transformers and inductors have some amount of leakage flux, but low permeability materials exhibit more leakage flux than high permeability materials. High permeability ferrite is commonly gapped to prevent saturation. A single gap is typically used. The leakage flux in this structure is thereby concentrated around the single air-gap. A low permeability material like Kool M $\mu$  has a distributed air-gap and hence the leakage flux is distributed around the core structure.

Leakage flux increases the effective area and decreases the effective path length of a magnetic core. Consequently on a low permeability core the measured inductance is always higher than the calculated inductance, see the following equation:

$$L = .4 \pi \mu N^2 A_e 10^{-8} / l_e$$

where: L = inductance in Henries  
 $\mu$  = core permeability  
N = number of turns  
 $A_e$  = effective cross section in cm<sup>2</sup>  
 $l_e$  = core magnetic path length in cm

Core dimensions also affect leakage flux. In the case of an E-core, a core with a longer winding length will have less leakage than a core with a shorter winding length. Also, a core with a greater winding build will have more leakage than a core with less winding build.

## External Leakage Field

Core shape affects the external leakage field. The E-core shape, where most of the core surrounds the winding, has a greater external leakage field than the toroidal shape, where the winding surrounds the core. The external leakage field of the E-core shape must be considered when using Kool M $\mu$  E-cores. Kool M $\mu$  E-cores should not be assembled with metallic brackets since the leakage flux will concentrate in the brackets and increase total losses. The leakage field must be considered when laying out the circuit board. Components susceptible to a stray magnetic field should be spaced away from the Kool M $\mu$  E-core, similar to the spacing from a gapped ferrite. For more information on this subject contact Magnetics Applications Engineering group for a copy of a white paper on the "Leakage Flux Considerations on Kool M $\mu$  E-Cores".

## Hardware

Hardware is available for most Kool M $\mu$  E-core sizes, see Table 3. Plain, or un-pinned, bobbins are also available for most sizes. Refer to Magnetics Powder Core Design Manual, page 5.5 for details. The cores are standard industry sizes that will fit standard bobbins available from many sources. Core pieces can be assembled by bonding the mating surfaces and taping around the perimeter of the core set.

**Table 3**

| Core Number           | Bobbin Number | Number of Pins | Winding Area (in <sup>2</sup> ) | Winding Area (cm <sup>2</sup> ) | Length per Turn (ft) | Length per Turn (cm) |
|-----------------------|---------------|----------------|---------------------------------|---------------------------------|----------------------|----------------------|
| 00K1808E (EI-187)     | PCB180881     | 8              | 0.049                           | 0.316                           | 0.133                | 4.05                 |
| 00K2510E (E-2425)     | PCB2510T1     | 10             | 0.063                           | 0.406                           | 0.178                | 5.42                 |
| 00K3007E (DIN 30/7)   | PCB3007T1     | 10             | 0.129                           | 0.833                           | 0.180                | 5.48                 |
| 00K3515E (EI-375)     | PCB3515L1     | 12             | 0.147                           | 0.948                           | 0.241                | 7.34                 |
| 00K4020E (DIN 42/15)  | PCB4020L1     | 12             | 0.300                           | 1.94                            | 0.300                | 9.14                 |
| 00K4022E (DIN 42/20)  | PCB4022L1     | 12             | 0.300                           | 1.94                            | 0.335                | 10.21                |
| 00K4317E (EI-21)      | PCB4317L1     | 12             | 0.156                           | 1.01                            | 0.281                | 8.56                 |
| 00K5528E (DIN 55/21)  | PCB5528WA     | 20             | 0.468                           | 3.02                            | 0.352                | 10.73                |
| 00K5530E (DIN 55/25)  | PCB5530FA     | 14             | 0.448                           | 2.89                            | 0.439                | 13.38                |
| 00K7228E (F11)        | 00B722801     | -              | 0.632                           | 4.08                            | 0.49                 | 14.94                |
| 00K8020E (Metric E80) | 00B802001     | -              | 1.25                            | 8.06                            | 0.542                | 16.52                |

## Expansion

Expansion of the Kool M $\mu$  E-core size range can be expected in the future. Hardware, where applicable, will be offered along with the cores. In addition, U shape cores and blocks will also be offered (some sizes are available now). Stay in contact with Magnetics' Applications Engineering department or visit our website for future product announcements.

## Core Selection Procedure

Only two parameters of the design application must be known: inductance required with dc bias, and the dc current. Use the following procedure to determine the core size and number of turns.

1. Compute the product of  $LI^2$ , where:  $L$  = inductance required with dc bias (mH)  
 $I$  = dc current (amperes)
2. Locate the  $LI^2$  value on the Core Selector Chart (page 8). Follow this coordinate to the intersection with the first core size that lies above the diagonal permeability line (small core sizes are at the bottom; large core sizes are at the top). This is the smallest core size that can be used.
3. The permeability line is sectioned into standard available core permeabilities. Selecting the permeability indicated will yield the smallest core that can be used. Lower or higher permeabilities can be used, but the resulting core size will be larger.
4. Inductance, core size, and permeability are now known. Calculate the number of turns by using the following procedure:
  - a) The nominal inductance ( $A_L$  in mH / 1000 turns) for the core is obtained from the core data sheet. Determine the minimum nominal inductance by using the worst-case negative tolerance (-8%). With this information, calculate the number of turns needed to obtain the required inductance in mH by using:  $N = (L \times 10^6 / A_L)^{1/2}$
  - b) Calculate the bias in oersteds from:  $H = 0.4\pi NI / l_e$  (with  $l_e$  in cm)
  - c) From the Permeability vs. DC Bias curves, determine the roll-off in per unit of initial permeability (mpu) for the previously calculated bias level.
  - d) Increase the number of turns by dividing the initial number of turns (from step 4a) by the per unit value of initial permeability (mpu). This will yield an inductance close to the required value. A final adjustment of turns may be necessary if a specific inductance is required.
5. Choose the correct wire size using the Wire Table. Duty cycles below 100% allow smaller wire sizes and lower winding factors, but do not allow smaller core sizes.
6. The core chosen will have an inductance equal to or greater than that required when biased with the specified dc current. The resulting winding factor will be between 50% and 80%.

# Core Selector Chart

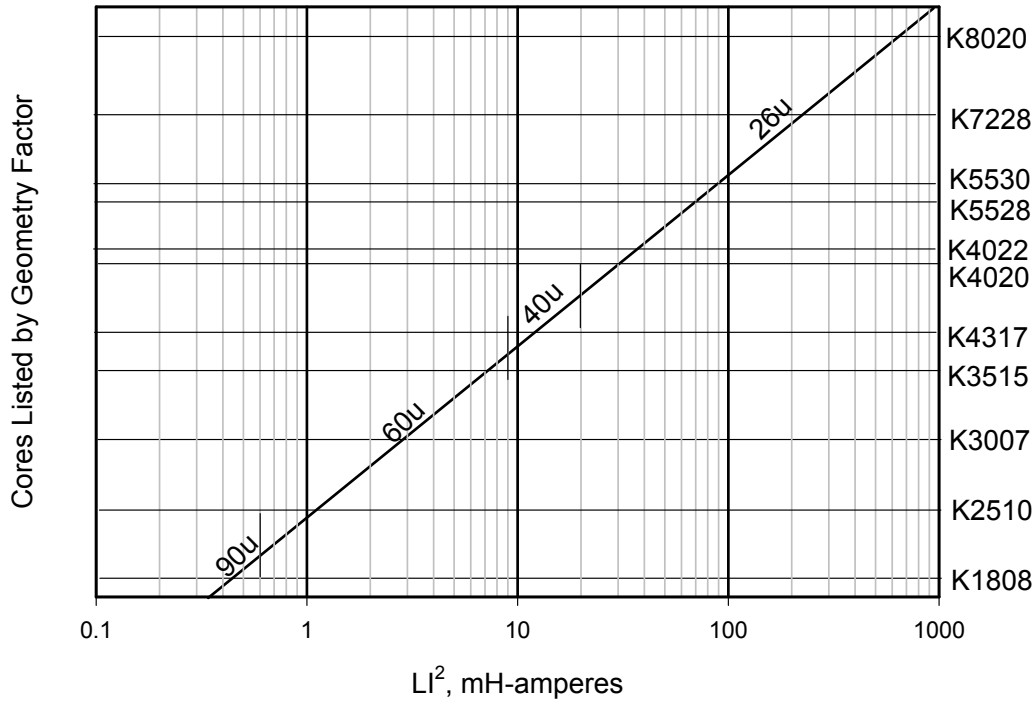

The chart above will quickly yield optimum permeability and smallest core size for DC bias applications. This chart is based on a permeability reduction of not more than 20% with dc bias, typical winding factors of 50 to 80% of the bobbin, and an AC current which is small relative to the DC current. The chart is based on the minimum inductance tolerance of the chosen core size and permeability.

If a core is being chosen for use with a large AC current relative to any DC current, such as a flyback inductor, select a core one size larger than indicated by the above chart. This will assist in reducing the operating flux density of the AC current that generates core losses.

MAGNETICS  
P.O. Box 11422  
Pittsburgh, PA 15238  
FAX: 412-696-0333  
Phone: 412-696-1300  
**1-800-245-3984**  
website: [www.mag-inc.com](http://www.mag-inc.com)  
e-mail: [magnetics@spang.com](mailto:magnetics@spang.com)